

**STEINER**   
Nothing Escapes You



## CONTENT

6 TECHNOLOGY & INNOVATIONS

## HUNTING

### THERMAL DEVICES

14 NIGHTHUNTER H35

16 NIGHTHUNTER C35

18 NIGHTHUNTER S35

### BINOCULARS

20 NIGHTHUNTER

22 RANGER XTREME

24 OBSERVER

### RIFLESCOPES

26 RANGER 6

28 RANGER 4

30 MRS - MICRO REFLEX SIGHT

## SHOOTING

### RIFLESCOPES

34 M7Xi IFS

38 M7Xi / M8Xi

40 M5Xi

### SIGHTS

42 S-SIGHTS

44 T-SIGHTS

46 MPS - MICRO PISTOL SIGHT

## ADVENTURE

50 WILDLIFE

52 SKYHAWK 4.0

54 BLUHORIZONS

56 SAFARI ULTRASHARP

## MARINE

60 COMMANDER

64 NAVIGATOR

## INFORMATION

66 SPECIFICATIONS  
BINOCULARS

68 SPECIFICATIONS  
RIFLESCOPES

69 SPECIFICATIONS  
SIGHTS

69 RETICLES

70 ACCESSORIES

71 WARRANTY /  
CUSTOMER SERVICE



## STEINER INNOVATING FOR 70 YEARS



STEINER invents nitrogen filling for fog-free and waterproof binoculars.

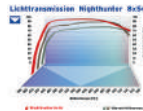

Introduction of the Nighthunter concept - highest standard in light transmission for hunting models.



Steiner is joining the Beretta Group.



Steiner introduces a new line of riflescopes for military and hunting.



The new Nighthunter generation sets new standards with light transmission of over 96%.



Steiner sets the new standard for sniper riflescopes with the IFS

1967



Makrolon housing: New housing plastic - developed for BAYER - for particularly robust binoculars.

1973

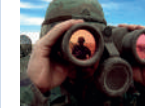

STEINER colour coating conquers the market: ruby coating, CAT (Colour Adjustment Transmission), M22 with laser protection filter.

1988

2000



STEINER is the first manufacturer to offer binoculars with Nano-Protection on the lenses.

2006

2008



Revolutionary laser technologies with the LRF (Laser Range Finder).

2009

2012



First red dot sight with integrated rangefinder.

2014

2016



Equipping the German Special Forces Command with the targeting optics for the G29.

2016

2019



Introduction of the first Thermal Device as a fully digital product.

2021



# FOREWORD

## Over 70 years of history.

Anyone who looks through Steiner binoculars can sense the passion and the fascinating success story of the traditional company, which was founded by Karl Steiner in 1947. Today, the company is a renowned international enterprise and has 150 employees in Bayreuth. Steiner-Optik is active in more than 80 countries around the world. The name Steiner-Optik has stood for top quality workmanship and precision craftsmanship for over 70 years.

The vision of technically perfect binoculars that optimally inspire people in their experiences guided Karl Steiner throughout his life. This claim, which was continued by his son Carl Steiner, still stands as the company's guiding principle today. Steiner binoculars and riflescopes symbolise optical innovation and embody the highest quality in their workmanship. With a wide range of products in the fields of hunting, water sports and outdoor adventure, Steiner-Optik offers the ideal product for every user, from beginners to professionals.

Steiner in Bayreuth is the embodiment of maximum quality and trend-setting developments. The company philosophy is based not only on trust and consistency for customers, but also for partners and employees. The company's success story is based on enduring values, family tradition, maintaining Germany as a production location, creating new jobs, training qualified personnel and investing in research and development. Both the "Made in Germany"

and "handmade by Steiner" seals of quality demonstrate first-class and durable technology. Steiner binoculars can therefore withstand even the toughest demands. No product leaves production without functional and material testing that is unrivalled in the industry and guarantees the optical brilliance and perfect functionality of the products. In order to constantly perfect the quality from Steiner, standards are constantly being redefined.

This is why Steiner can claim to be the global market leader in professional high-tech binoculars. Today, the factory in Bayreuth is one of the world's most modern production and research facilities for binoculars and target optics. Investments in the millions at the Bayreuth site create the prerequisites of personnel and technology that are required for continued success.

Steiner has also been the undisputed market leader for marine binoculars and the inventor of the compass binocular for many years, making it the first choice for sailors and captains from large ships to small boats. Every professional user relies on the outstanding quality and safety that only the special Steiner binoculars offer.

Since August 2008, Steiner-Optik has been part of the Beretta group of companies. The Italian firearm manufacturer Beretta was first mentioned in a document as early as 1526, making it the oldest firearm manufacturer in the world. The Beretta group of companies includes Benelli, Uberti, Sako, Tikka and Burris, among others.

## 3D VIEW

Steiner porro prism binoculars are extremely robust and reliable. Ideal, therefore, for rigorous applications in any terrain, including the high seas. The porro system naturally delivers a realistic 3D image with maximum depth of field and outstanding clarity, allowing pinpoint laser range finding up to 1,700m at the touch of a button in a compact pair of binoculars. Even over vast distances, the user can clearly see whether one object is in front or behind the other.

Once adjusted to the eyes, a pair of porro binoculars will always provide a sharp image from 20 m, without the need for refocusing – and is therefore ideally suited for rapidly changing distances.



## STEINER – GERMANY'S BEST

The "Germany's Best" award was given on the basis of the number of points achieved in the overall ranking. The respective industry winner received the the top score of 100 points as described above, thus setting the benchmark benchmark for all other companies and brands surveyed within the industry.



## MORE LIGHT, BETTER IMAGE

All Steiner lenses are sourced through premium glass suppliers. The surfaces of the lenses are multi-coated. Innovative coatings made from rare fluorides and minerals maximise sharpness, colour and resolution. This demand for the highest glass quality makes the unsurpassed light transmission possible and consolidates Steiner's leading position on the world market.



## UNIQUE NITROGEN-PRESSURE SYSTEM



The Steiner nitrogen-pressure-system prevents dirt and moisture from infiltrating the inside of the binoculars. Lens fogging or the formation of condensation are impossible thanks to this proprietary high-tech solution. Due to the unique method of filling via the 2-way valve technology, maintenance of the binoculars possible even after many years.

## THE STEINER PROMISE...

With every optical quality product that leaves our factory, we give our customers across the world the promise that they can rely on Steiner products - no matter what the location or conditions - in any situation.

At Steiner, we have always taken care to ensure that each of our products is specialised for the toughest use. Accordingly, the features of ruggedness, precision and highest light transmission are top priorities for our customised optics products, so that our customers can quickly and precisely track, identify and achieve their targets. We underline this promise with our 30-year or 10-year guarantee, which applies to all our products. Together with our leading partners, we offer the best service in the industry.

## BUILT FOR EXTREME CHALLENGES

The use of new types of high-tech materials sets new standards for optical performance and ruggedness. With decades of user experience in more than 80 countries in the military sector, which also goes into our civilian products, we can say that Steiner makes the most robust binoculars in the world. Every single glass goes through demanding quality controls. Tests such as collimation, shock resistance, waterproofing and temperature resistance ensure that all our binoculars that leave the factory can withstand any extreme situation.



## CRAFTED TO SEE BETTER, NOT JUST FARTHER

Steiner-Optik in Bayreuth has been setting standards in the premium optics industry for over 70 years. The more than 460 rigorous steps that are necessary to produce the finished optics ensure the quality standards that we and our customers require for our optics products. Relentless research and development produces technologies such as nitrogen filling, laser protection filters, nano-protection and especially the Steiner-typical transmission-strong coatings. Consistent user feedback from water sports, hunting, military and outdoor sectors complement our user-focused product developments and associated top-level performance.



### GUARANTEED STEINER

The lenses and prisms for our premium optics are ground and polished by ourselves in the state-of-the-art factory in Bayreuth.

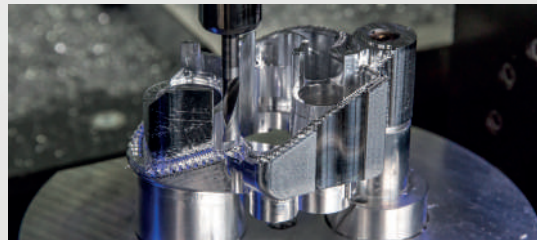

### 100 % PRECISION

The multi-coated optics and all other components are assembled in the polycarbonate or magnesium die-cast housing in more than 460 high-precision manufacturing and inspection steps.



### PERFECT COATINGS

The coatings developed and vapour-deposited in-house by Steiner are designed to increase light transmission, enhance contrast and provide a sharp image, even under unfavourable lighting conditions.

# HUNTING

**IT STANDS FOR: PASSION, HARD  
WORK AND VISION TO DO THE RIGHT  
THING AT THE RIGHT MOMENT!**

In order to be able to meet the high demands of hunting on a daily basis, hunters must unquestioningly rely on their equipment! Here, the functionality as well as the uncompromising quality of the hunting optics play a decisive role: extreme ruggedness - even under the toughest conditions - must be a given. But an authentic passion product for hunters can only be created if the performance of the optics also meets the highest demands and thus the most adverse weather and visibility conditions without limitation. Steiner hunting optics combine these characteristics, as they were developed by hunters for hunters. This means you are always that decisive moment ahead when hunting - every day anew!

## **THERMAL DEVICES**

**NIGHTHUNTER H35  
NIGHTHUNTER C35  
NIGHTHUNTER S35**

## **BINOCULARS**

**NIGHTHUNTER  
RANGER XTREME  
OBSERVER**

## **RIFLESCOPES**

**RANGER  
RANGER BC  
MICRO REFLEX SIGHT**







# THERMAL

## THE REVOLUTION OF A LEGEND

Steiner has always been known for the best optical performance especially in twilight conditions. With the Nighthunter product family, we have developed the best optics on the market for low light conditions. Our ambition to perfect and improve the best observing experience has inspired us to create the Nighthunter family. And has motivated us to take the Nighthunter family into the world of digital thermal imaging.

THERMAL DEVICES  
NIGHTHUNTER H35  
NIGHTHUNTER C35  
NIGHTHUNTER S35







# STEINER NIGHTHUNTER

"Steiner Nighthunter" has always been a synonym for ultimate hunting success; the new Nighthunter H35 enters the thermal market and will not only fulfill this not only meet, but exceed it.

We make a promise today: Excellent observation as always, but also technological innovation paired with the highest reliability. At the heart of the Nighthunter H35 is Quantum Vision.

The perfect combination of the most advanced thermal sensor, outstanding display quality and secret software development. Quantum Vision Technology together with outstanding ease of use, handling and the legendary Steiner ruggedness creates the product you've been waiting for: once again, almost an unfair advantage.



# QUANTUM VISION™ – THE HEART OF THE NIGHTHUNTER

It is a perfect combination of state-of-the-art thermal sensor, outstanding display quality and secret software development. Quantum vision™ technology together with outstanding usability, handling and the legendary Steiner ruggedness creates the product you were waiting for.

## BE FAST

- High speed software
- Fastest detection
- Automatic calibration
- Clear pictures of moving targets

## SEE THE DIFFERENCE

- The sharpest thermal image
- Impressive recognition
- Various color pallets
- Perfection in any light condition

## SUCCEED

- See details while others guess
- Connect. Stream. Share.

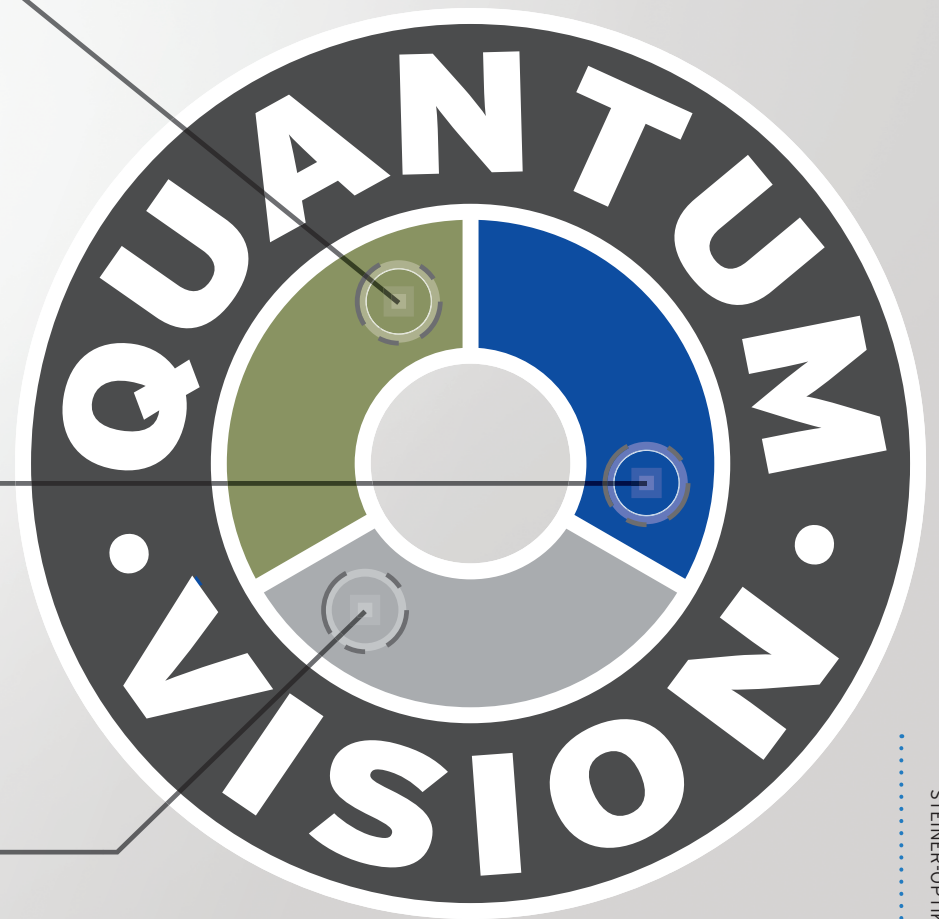

**NEW**

## NIGHTHUNTER H35



Comfortable observation with maximum sharpness of detail for the decisive moments. High contrast for precise identification, while others are just guessing.

**Item No. 8700000101**

MAGNIFICATION 2x | WEIGHT 695g | LENGTH 232mm | HEIGHT 72mm

Steiner Nighthunter products have always stood for the best optical performance in difficult light conditions and the ultimate in hunting success. With the new **NIGHTHUNTER H35**, we are once again living up to this claim and transferring it to the new electro-optical world. At the same time, we make the promise that with the Nighthunter H35 you get excellent observation quality, the greatest reliability and the highest technological innovation.

### ..... NIGHTHUNTER H35 OVERALL FEATURES .....

#### OPTIMAL USER-FRIENDLINESS:

- ERGONOMIC SHAPE for easy use
- PRACTICAL OPERATION for maximum effectiveness
- EFFECTIVE RECOGNITION in any environment

#### LEGENDARY RUGGEDNESS:

- PROTECTIVE ARMORING to absorb any impact
- FOR THE HARDEST USE and tested by professionals
- NOISE REDUCTION for covert hunting

**FUNCTIONAL CARRYING POCKET** with high-quality accessories

**FULL USABILITY** even under extreme temperatures

**OVER 4.5 HOURS OF OPERATION QUANTUM VISION TECHNOLOGY**

**QUANTUM VISION TECHNOLOGY**

**NEW STEINER CONNECT APP** for image, video, streaming and WiFi

### STEINER CONNECT APP



**CONNECT.  
STREAM.  
SHARE.  
REMEMBER.**

CONNECTABLE WITH EVERY NIGHTHUNTER THERMAL DEVICE



STEINER-OPTIK



#### RANGE

0m 500m 1000m 1500m 2000m 2500m 3000m 3500m

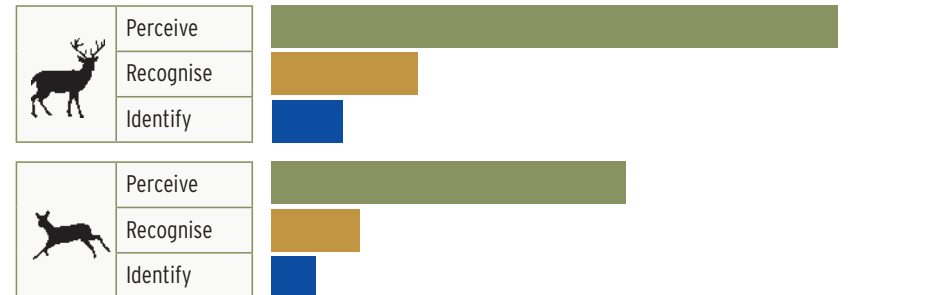

# NIGHTHUNTER H35 **NEW**



**BE FAST.  
SEE THE DIFFERENCE.  
SUCCEED.**

The perfect combination of state-of-the-art thermal sensor, outstanding display quality and advanced software development.

**NEW**

## NIGHTHUNTER C35



The simple adapter system of the C35 makes it easy to integrate with your day scope which will ultimately lead to undoubted hunting success.

**Item No. 8700000102**

MAGNIFICATION 1x-8x | WEIGHT 785g | LENGTH 177mm | HEIGHT 62mm

\* Please make sure that you are allowed to purchase a thermal rifle scope or clip-on for hunting in your individual country. Steiner is not liable for any violation of law when using the Steiner Product in a manner not admissible according to national law regulations.

### STEINER CONNECT APP



**CONNECT.  
STREAM.  
SHARE.  
REMEMBER.**

CONNECTABLE WITH EVERY NIGHTHUNTER THERMAL DEVICE



The Steiner **NIGHTHUNTER CLIP-ON\*** impresses with an incredibly rugged housing and ultra-sharp images, thanks to its outstanding sensor, software and image display. With the **C35** you will be able to approach game where others are still guessing.

### ..... NIGHTHUNTER C35 OVERALL FEATURES .....

#### THE ULTIMATE HUNTING SUCCESS:

- ALL DETAILS AT A GLANCE - Outstanding sensor with 640 x 480 which is displayed on an 800 x 600 OLED display.
- SAFE APPROACH even in challenging shots on the move. The 50Hz frame rate ensures a clear image of the game body without any misalignment.
- THE PERFECT CHOICE FOR ALL HUNTING SCENARIOS  
The auto-calibration and magnification capability of 1-8x digital zoom allows the use in all hunting situations.

#### QUICK AND EASY TO USE:

- EXTREMELY EASY AND RELIABLE ATTACHMENT TO THE SCOPE
- PLUG AND PLAY - READY FOR INSTANT USE
- MAXIMUM SAFETY DURING THE HUNT

**ALWAYS READY FOR ACTION** even under extreme temperatures

**EASY POWER SUPPLY** through replaceable batteries or USB-C with Powerbank

#### QUANTUM VISION TECHNOLOGY

**NEW STEINER CONNECT APP** for image, video, streaming and WiFi

#### RANGE

0m 500m 1000m 1500m 2000m 2500m 3000m 3500m

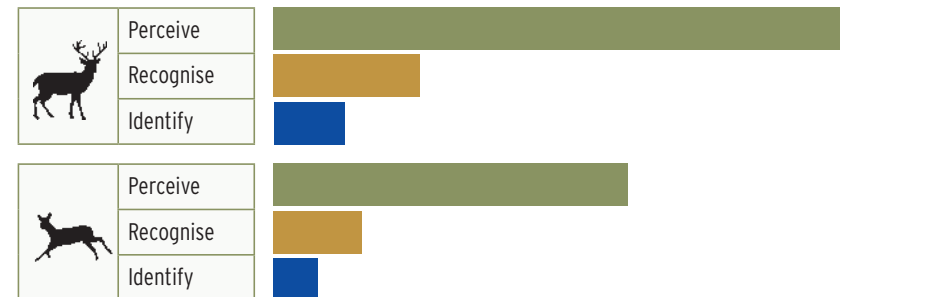

STEINER-OPTIK



# NIGHTHUNTER C35 **NEW**

**BE FAST.  
SEE THE DIFFERENCE.  
SUCCEED.**

The perfect combination of state-of-the-art thermal sensor, outstanding display quality and advanced software development.



**NEW**

## NIGHTHUNTER S35



A unique thermal riflescope designed to work in even the most challenging conditions for giving clear, reliable and detailed images time after time.

**Item No. 870000103**

MAGNIFICATION 1x-8x | WEIGHT 1043g | LENGTH 215mm | HEIGHT 85mm

\* Please make sure that you are allowed to purchase a thermal riflescope or clip-on for hunting in your individual country. Steiner is not liable for any violation of law when using the Steiner Product in a manner not admissible according to national law regulations.

The Steiner **NIGHTHUNTER S35\*** thermal scope combines unparalleled optical performance with class leading digital thermal technology. Like all Steiner optical and thermal products the **S35** has been designed to work in even the most challenging conditions.

### ..... NIGHTHUNTER S35 OVERALL FEATURES .....

#### DETAILED AND PRECISE:

- ALL RELEVANT DETAILS AT A GLANCE - Outstanding sensor with 640 x 480 which is displayed on a detailed 800 x 600 OLED screen.
- CONFIDENT APPROACH EVEN IN CHALLENGING SHOTS  
50Hz frame rate ensures fast and accurate response to game.
- HIGHEST PRECISION  
The automatic calibration and the magnification option of 1-8x digital zoom allows for safe aiming and shooting in any condition.

#### EASY SHOOTING WITH COMFORTABLE OPERATION:

- INTUITIVE SIGHTING-IN FOR FAST AND PRECISE ADJUSTMENTS
- SILENT AND FAST FOCUSING
- UNOBSTRUCTED VIEW WITHOUT DISTRACTION THANKS TO ADAPTED EYECUP

**EXTREMELY RESISTANT** to any caliber (Tested at 800G)

**EASY POWER SUPPLY** through replaceable batteries or USB-C with Powerbank

#### QUANTUM VISION TECHNOLOGY

**NEW STEINER CONNECT APP** for image, video, streaming and WiFi

### STEINER CONNECT APP



**CONNECT.  
STREAM.  
SHARE.  
REMEMBER.**

CONNECTABLE WITH EVERY NIGHTHUNTER THERMAL DEVICE



STEINER-OPTIK



#### RANGE

0m 500m 1000m 1500m 2000m 2500m 3000m 3500m

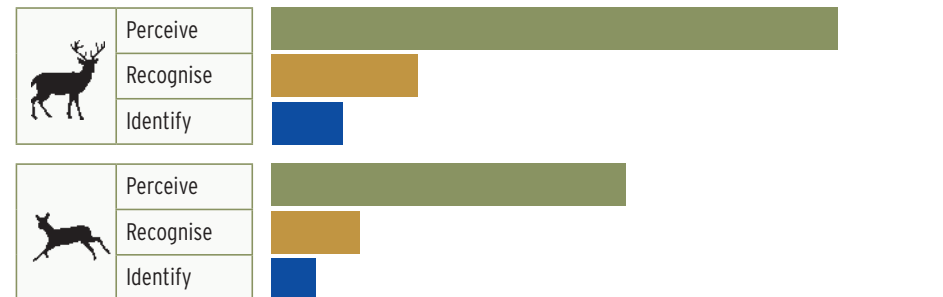

# NIGHTHUNTER S35 **NEW**

**BE FAST.  
SEE THE DIFFERENCE.  
SUCCEED.**

The perfect combination of state-of-the-art thermal sensor, outstanding display quality and advanced software development.





# 8X56 NIGHTHUNTER 8X56

Experience for yourself the next evolutionary step of the ultimate night hunting binoculars made by Steiner!

Item No. 2310

MAGNIFICATION 8x | FIELD OF VIEW 135m | WEIGHT 1090g



**CONTOURED EYE CUPS**  
fold over for eyeglasses use



**XL FIELD OF VIEW**  
135 m on 1000 m



**MAXIMUM LIGHT TRANSMISSION (96%+)**

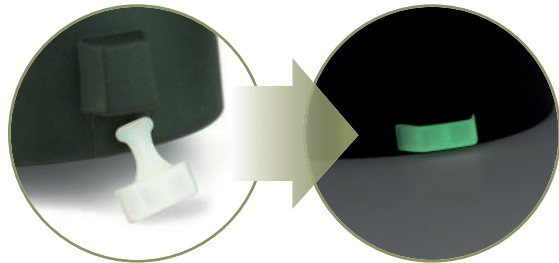

**STEINER LUMICLIP**  
simple yet innovative to easily locate your binoculars!



**CLICLOC** strap attachment for instant neck strap release.

The evolution of a legend – The new **NIGHTHUNTER 8X56** gives you the ability to identify game and take ethical shots when others cannot. Steiner's latest developments in binocular technology are the result of 70 years of optical development and innovation. This technology, combined with Steiner's hunting heritage, produces the ultimate optic for night hunting. The new Steiner Nighthunter – almost like having an unfair advantage.

..... **NIGHTHUNTER OVERALL FEATURES** .....

- **MAXIMUM (96%+) LIGHT TRANSMISSION:** Success in hunting is about the odds. The longer you can hunt the better your odds of success. Extend your hunt every night. One more chance-one more look-one more shot. Steiner's advanced technology penetrates the shadows with incredibly bright images – See what other hunters are missing.
- **SPORTS-AUTO-FOCUS:** No need to fumble in the night chasing focus. To view objects in low light there is no bettersystem. Focus each eyepiece to your vision once, and then count on razor-sharp images from 20 meters to infinity. Clearly have the ability to determine your trophy of a lifetime no matter the darkness – Perfect focus all the time.
- **WIDE FIELD OF VIEW:** The more you can see the better hunter you can be. See every animal in the field and let Nothing Escape You with a huge 135-meter field of view.
- **CLARITY IN THE NIGHT:** Male or female? Trophy or not? Without a pair of Nighthunters you may never know – The porro prism design produces three-dimensional depth perception to quickly locate and evaluate your target. Add to this Steiner's proprietary Diamond Night lens coating formula and you have superior clarity and contrast at dusk and dawn giving extra minutes of prime hunting time.
- **RUGGEDNESS, PRECISION AND PERFORMANCE:** Steiner's always function when you need them. No worries when it comes to durability. With more than half a century of battle-proven reliability there are no better rugged-built optics that perform like a Steiner.
- **CONTOURED EYE CUPS:** Holding your binoculars in a way to block the sun with your hands can be awkward. Peripheral light while using binoculars can impair your vision no matter the time of day. Steiner's patented eyecups allow you to take advantage of the Nighthunter's amazing optical technology and always see the clearest image possible.
- **STEINER LUMICLIP:** When you can hear your prey but can't see him you must be quiet as a field mouse. Don't stumble in the dark groping for your binoculars creating noise that will send game running. Steiner's new LumiClip is simple yet innovative. The luminescent clip glows with just enough light to easily locate your binoculars in the darkest night.

# NIGHTHUNTER

## THE EVOLUTION OF A LEGEND

Overcome dawn, dusk and distance with images so bright and sharp you can count points, from a ridge away, at sunset. For big game, not even the shadows are safe.



STEINER-OPTIK

HUNTING



# 8X56

## RANGER XTREME 8X56

Large 56 mm objectives result in maximum light transmission for maximum clarity and sharp contrast at dawn and dusk.

Item No. 5118

MAGNIFICATION 8x | FIELD OF VIEW 125m | WEIGHT 1130g



# 10X42

## RANGER XTREME 10X42

Features 10 x magnification to judge points or mass at shooting distance and track game at long range, with brightness to weight performance nothing in its category can match.

Item No. 5117

MAGNIFICATION 10x | FIELD OF VIEW 108m | WEIGHT 790g

The **RANGER XTREME SERIES** was made for the ambitious hunter who expects a binocular to hunt as hard and as long as he does. You often get your best results at day's edge, when prey feed camouflaged by early sun or growing darkness. The light enhancing design of Ranger Xtreme binoculars unlocks the shadows they hide in, giving you clear game-spotting vision in dim light. In full light, it lets you peer deeper in darkened woods, revealing sign and quarry that other hunters miss.

### RANGER XTREME OVERALL FEATURES

- **STEINER HIGH-CONTRAST-OPTICS** provide bright, brilliant views, accurate colour and clear images with high contour sharpness for exceptional performance up to close range of 2 m.
- **FAST-CLOSE-FOCUS** central focusing wheel requires minimal, stepless rotation for quick absolute sharpness from close-up to infinity- comfortable, easy to use.
- **OUTSTANDING RUGGEDNESS** with durable polycarbonate Makrolon housing, Water Pressure Proofness to 3m and the Nitrogen-Pressure-Filling into the optic against fogging up inside at temperature range between -20 °C to +80 °C. Non-slip NBR-Longlife rubber armour protection resists oil, acid or adverse weather. Impervious to harsh conditions for generations of trusted use.
- **XL FIELD OF VIEW** ensures an overview of search and observations activities.
- **ERGONOMIC DESIGN** with rubber armoured protruding controls providing comfortable and silent observations with effective sound absorption. Ergonomic pliable eyecups made of soft, skin-friendly and non-ageing silicone protect against incident light and draught. Simply to be folded down for use with eyeglasses. Thumb depressions for an excellent grip, even with gloves.
- **CLICLOC-STRAP ATTACHMENT SYSTEM** attaches and releases neck strap with instant, push-button ease, and keeps binoculars hanging straight and action-ready.
- **HIGH-END ACCESSORIES** with high-end case, ClicLoc neoprene-carrying strap for instant, push-button ease, rain protection cap and objective covers.



# 8X42

## RANGER XTREME 8X42

Versatile, compact and easy to carry, perfect for rifle hunting in a variety of environments. A lightweight all-terrain favourite with a great field of view.

Item No. 5116

MAGNIFICATION 8x | FIELD OF VIEW 125m | WEIGHT 780g



# 8X32

## RANGER XTREME 8X32

Light and compact, ideal for mobile hunters who need the versatility of good magnification and wide view.

Item No. 5119

MAGNIFICATION 8x | FIELD OF VIEW 133m | WEIGHT 620g



STEINER-OPTIK

# RANGER XTREME



SUCCESSFUL HUNTING  
IN LOW LIGHT CONDITIONS.

10 YEAR\*  
WARRANTY

STEINER-OPTIK



# 8X56

## OBSERVER 8X56

The new nitrogen-filled Observer 8x56 guarantees you to spot your game in all weather conditions.

Item No. 2335

MAGNIFICATION 8x | FIELD OF VIEW 112m | WEIGHT 1130g



# 10X42

## OBSERVER 10X42

10x power and bright images are perfect for long range detailed observations from close up to far away without added weight.

Item No. 2314

MAGNIFICATION 10x | FIELD OF VIEW 100m | WEIGHT 706g



# 8X42

## OBSERVER 8X42

A versatile all-round binocular. Light-weight with bright images until twilight.

Item No. 2313

MAGNIFICATION 8x | FIELD OF VIEW 116m | WEIGHT 696g

The new **OBSERVER SERIES** are designed for a versatile use to match any situation under all conditions. Three full sized models in a lightweight design provide comfortable ergonomics for long-term observation, bright images, crisp resolution and a wide field of view. Hardly any other binocular gets you so close with such clear, sharp detail, for so little budget.

### ..... OBESERVER OVERALL FEATURES .....

- **STEINER HIGH-CONTRAST-OPTICS** provide bright, brilliant views, accurate colour and clear images with high contour sharpness for exceptional performance up to close range of 2 m.
- **FAST-CLOSE-FOCUS** central focusing wheel requires minimal, stepless rotation for quick absolute sharpness from close-up to infinity. Comfortable, easy to use.
- **OUTSTANDING RUGGEDNESS** with durable polycarbonate Makrolon housing, temperature range between -15°C to +55°C. Non-slip NBR-Longlife rubber armour protection resists oil, acid or adverse weather.
- **ERGONOMIC DESIGN** with rubber armoured protruding controls providing comfortable and silent observations with effective sound absorption.
- **CYLINDRIC ROTATION EYECUPS** made of soft, skin-friendly and non-aging silicone.
- **LIGHTWEIGHT ROOF-PRISM DESIGN** has less bulk to stay out of the way while observing.
- **FULL ACCESSORIES** with bag, carrying strap, rain cover and lenses covers.



STEINER-OPTIK



# OBSERVER



## THE PERFECT ALLROUND COMPANION

For anyone who demand versatile capability in their optics.

10 YEAR\*  
WARRANTY

STEINER-OPTIK

HUNTING

25

## RANGER 6 1-6X24



**THE DRIVEN HUNT SPECIALIST:** A classic driven-hunt riflescope with a large field of view across the magnification range. At 1x magnification, the field of view is an impressive 40.75 m at 100 m distance. The 4A-I illuminated reticle dot ensures fast target acquisition for shooting on the run and is also ideal for big game hunting.

Item No. 8765900204

TUBE DIAMETER 30 mm | LENGTH 268 mm | WEIGHT 490 g

## RANGER 6 3-18X56



**THE ALL-ROUND SCOPE:** This universal riflescope is ideal for various types of hunting. With its large field of view, it is the perfect choice during stalking or stand hunting at night. It also features the 4A-I illuminated reticle that is adjustable for optimum brightness in daylight or very low residual light at night.

Item No. 8767900204

TUBE DIAMETER 63,5 mm | LENGTH 338 mm | WEIGHT 754 g

Since their introduction in 2015, the Steiner Rangers have become one of the most successful series in Europe. We are now introducing the new **RANGER 6-SERIES** with many new innovations, improvements and the usual Steiner standard of quality. The innovative and consistent further development of the successful Ranger series.

### RANGER BC OVERALL FEATURES

- **STEINER HIGH-CONTRAST-ED-OPTICS**  
The game stands out even more clearly from its surroundings with this special optic. We wanted to make it possible for hunters to react safely in all situations.
- **OUTSTANDING LIGHT TRANSMISSION (92%+)**  
Steiner's most advanced technology breaks through the darkness with incredibly bright images - take advantage of opportunities other hunters miss.
- **SIMPLE AND COMPACT HANDLING**  
due to the shorter length of the riflescope, we enable not only compact handling but also the easy use of modern additional clip-on devices, which can be combined according to preference.
- **XL FIELD OF VIEW**  
40,75 m on 100 m (for Ranger 6 1-6x24) for perfect overview and safety in every situation.
- **PRECISE CLICK ADJUSTMENT**  
Audible and tactile click for intuitive operation in difficult lighting conditions.
- **STEINER ZEROMODE**  
In order to offer the perfect riflescope even in demanding situations, we have integrated the Zero Stop technology in our Ranger 6 riflescope for long-distance shots. After adjustment, the turret of the height control can always be reliably turned back to 0.
- **3-18X56 AVAILABLE WITH INTEGRATED BALLISTIC TURRET**
- **3-18X56 AVAILABLE ALSO WITH S3I RETICLE**



# RANGER 6

## EXCELLENT OPTICS AND INTUITIVE USE IN A COMPACT DESIGN

Compact versatility for virtually any firearm  
with excellent optical performance,  
that finds each target in its environment.



## PERFECT ACCESSORIES: BALLISTIC CAPS



10 YEAR  
WARRANTY\*

STEINER-OPTIK

HUNTING

27

## RANGER 4 1-4X24



**THE DRIVEN HUNT SCOPE:** The perfect scope for fleeting shooting thanks to crystal clear illuminated dot and XL field of view.

Item No. 8769900204

TUBE DIAMETER 30 mm | LENGTH 290 mm | WEIGHT 500 g

## RANGER 4 2,5-10X50



**THE ALLROUNDER:** A powerful riflescope that offers versatility through its impressive optical performance, especially in challenging situations.

Item No. 8770900204

TUBE DIAMETER 57,5 mm | LENGTH 340 mm | WEIGHT 620 g

**NEW**

## RANGER 4 4-16X56



**FOR CHALLENGING SHOTS:** The specialist for hunting in difficult lighting conditions and for long-range as well as high precision shots.

Item No. 8775900404

TUBE DIAMETER 63,5 mm | LENGTH 375 mm | WEIGHT 680 g

## RANGER 4 6-24X56



**THE RANGE SPECIALIST:** The perfect tool for ambitious hunters and shooters, allowing highly accurate shots at long distances.

Item No. 8774900404

TUBE DIAMETER 63,5 mm | LENGTH 375 mm | WEIGHT 680 g

The evolution of the successful **RANGER RIFLESCOPE SERIES** offers everything you could wish for and much more, with optimised optical quality, reliable mechanics and outstanding ruggedness according to Steiner promises. A high-magnification riflescope and models with integrated mounting rail now complement the model range, so the new Ranger4 riflescopes will fully meet the diverse demands of hunters.

### RANGER 4 OVERALL FEATURES

- **XL-FIELD OF VIEW**  
For the greatest possible overview and the essential safety in every situation.
- **IMPROVED LIGHT TRANSMISSION**  
Light transmission of 90%, ensuring reliably bright images, even under the darkest conditions at twilight.
- **STEINER HIGH-CONTRAST OPTICS**  
Ensures fast, brilliant and high-contrast images with high edge-to-edge sharpness and outstanding detail recognition.
- **RELIABLE AND PRECISE MECHANICS**  
Convinces with its repeatable and precise reticle adjustment. Illumination, windage and elevation turrets are audible and tactile, providing intuitive operation for the use.
- **ELEGANT, LIGHTWEIGHT AND AESTHETIC DESIGN**  
The one-piece tubular bodies are coated with a satin and scratch-resistant hard anodizing according to highest standards, and with smooth transitions and elegant radii, they offer sufficient space for mounting attachments.

**NEW: also available as a rail variant**

for the models 1-4x24 and 3-12x56



STEINER-OPTIK

# RANGER 4

## DETERMINED IN PERFORMANCE

Outstanding optics and reliable mechanics in an optimised design. Powerful versatility and outstanding optical power for best performance.



RANGER 4 3-12X56



**THE NIGHT GLASS:** Powerful riflescope that stands out especially when hunting in the last light due to the high light transmission and the enlarged field of view.

Item No. 8771900204 TUBE DIAMETER 63,5 mm | LENGTH 354 mm | WEIGHT 640 g

OPTIONALLY  
WITH ZEISS INNER RAIL



10 YEAR  
WARRANTY\*

STEINER-OPTIK

HUNTING

29

Intuitive shooting with open eyes - the Steiner MRS offers this option for a fast and unerring shot. Extremely robust and with brilliant optics.



## MICRO REFLEX SIGHT PICATINNY RAIL

Item No. 8700000003 MAGNIFICATION 1x | WEIGHT 70g | WIDTH 46mm | HEIGHT 40mm



## MICRO REFLEX SIGHT UNIVERSAL RAIL

Item No. 8700000003 MAGNIFICATION 1x | WEIGHT 88g | WIDTH 46mm | HEIGHT 40mm

The prompt and accurate shot is the key to success in many hunting situations. At shorter distances, this is achieved with no other optics as easy as using the **Micro Reflex Sight (MRS)** red dot sight. In any weather and even in difficult lighting conditions. The ideal addition to your equipment.

### ..... MRS OVERALL FEATURES .....

- **HIGH-PERFORMANCE OPTICS:** High-resolution, crisp and clear image by multi-coated precision optics.
- **PERFECT USE:** Aiming with this optics is incredibly fast and safe. Regardless of the viewing distance and angle the red illuminated target point shows accurately to the target. Ideal for shooting with both eyes open.
- **COMPACT DESIGN:** The Steiner MRS impresses with its extremely compact design and is unsurpassed in terms of the low weight.
- **INTELLIGENT ILLUMINATION:** The automatic, environment-oriented illumination always provides the perfect brightness of the reticle. In addition, a 3-stage manual setting is possible. An Auto-Off switches the illumination of the reticle off after 8 hours.
- **EXTREME RUGGEDNESS:** Thanks to innovative sealing, moisture, dust and dirt cannot harm the optics of the Steiner MRS.
- **EASE OF USE:** The functions are controlled via a single key. Battery replacement is possible thanks to lateral compartment, without tools or dismantling of the optics.



### 3 MOA

Regardless of eye relief shows the red illuminated target point to the finish line. Ideal for shooting with both eyes open.



# MICRO REFLEX SIGHT



[ORIGINAL SIZE]

## FAST TARGET ACQUISITION UNDER ALL WEATHER CONDITIONS

Cristal clear red dot sight in every environment.  
Intuitive use. Compact and lightweight.

10 YEAR  
WARRANTY\*

STEINER-OPTIK

HUNTING

31

# SHOOTING

## BUILT FOR THE BEST – DESIGNED FOR SUCCESS

For many decades, Steiner products have been the first choice for military and special forces because they cannot compromise on precision, ruggedness and reliability.

Our products are tested to the highest military standards, guaranteeing unsurpassed optical and mechanical quality and performance, that is reflected in the unique reliability of our products.

Whether at the shooting range, in competition or in hunting - trust in the reliability of your own equipment is always indispensable.

We design the high-performance optics built for the best in the world - for superiority in every situation!

### RIFLESCOPES

M7Xi IFS  
M7Xi/M8Xi  
M5Xi  
S-SIGHTS  
T-SIGHTS  
MICRO PISTOL SIGHT







# 4-28X56

## M7Xi IFS 4-28X56



The Intelligent Firing Solution with integrated customizable display always provides all the important information in real time to the operator and sets a new benchmark as the ultimate long-range rifle scope.

Item No. 8719003601

TUBE DIAMETER 34 mm | LENGTH 390 mm | WEIGHT 1.150 g

**NEW**

# 2.9-20X50

## M7Xi IFS 2.9-20X50



Steiner enlarges the IFS line up of products including now also the versatile 2,9-20x50 IFS. With its wide zoom range it is ideal for any terrain and situation allowing for a fast and perfect shot from lower to mid-long range.

Item No. 8717003621

TUBE DIAMETER 34 mm | LENGTH 352 mm | WEIGHT 1.100 g

Steiner's new **M7Xi IFS** rifle scope offers an Intelligent Firing Solution Interface that provides important information to the operator about levelling and current turret setting in real time. The builtin Ballistic Calculator and Sensor Suite use temperature, air pressure, inclination and wind drift to determine the bullet point of impact in real time. The display and user interface can be customized via Smartphone App (Bluetooth connection to user needs. Information can be easily moved, arranged or deactivated if needed.)

### M7Xi IFS OVERALL FEATURES

- **IFS - INTELLIGENT FIRING SOLUTION** with individually customizable display in the field of view showing every required information in real time - once set and you never lose sight of the target.
- The built in **BALLISTIC CALCULATOR AND SENSOR SUITE** determines the bullet point of impact in real time.
- **INDIVIDUAL CUSTOMIZABLE DISPLAY** provides information about levelling and the current turret setting, allowing you to know the current exact shooting position in the field of view. Display and user interface can be customized to user needs.
- **BLUETOOTH-CONNECTIVITY** for easy set-up on the smart phone. Every information can be moved freely or can be deactivated if needed via smart-phone app.
- The **SHORT OVERALL LENGTH** of the scope creates more rail space for clip-on devices (e.g. thermal imaging or night vision devices) for superior operational capabilities in any combat situation.
- **PRECISE WINDAGE/ELEVATION ADJUSTMENT** is easy and accurate for repeatable accuracy, with tactile click-by-click feedback you can hear and feel.
- **LOW PROFILE TURRETS** provide outstanding situational awareness and additional mounting options for add-ons and accessories.
- **EXTREME RUGGEDNESS AND RELIABILITY** achieved through durable materials and reliable design. A sturdy 34mm tube provides reliability and more space for windage and elevation adjustments for longer shots.
- **WATERPROOF AND SHOCKPROOF**  
The M7Xi IFS is waterproof up to 20 m (66Feet) and the operating temperature range is -46°C to +64°C. It can withstand up to 900Gs
- **RETICLE VARIETY**  
The new M7Xi is available with MSR2, G2B, TReMoR3 reticle.



# M7Xi IFS

## LONG RANGE SHOOTING MADE SIMPLE...

Steiner's new M7Xi IFS riflescope -  
Always Stay On Target!



*"Image quality is outstanding; however, it is difficult to easily describe in words. There is no one single individual trait of the image viewed through the scope that is amazing, rather than **the excellent, almost perfect, balance of it** that pleasantly surprises the user."*

**all4shooters.com**  
BE A SHOOTER! ARMS AMMUNITION TECHNICS PASSION

10 YEAR  
WARRANTY\*

SHOOTING

STEINER-OPTIK

35

# LONG RANGE SHOOTING MADE SIMPLE

- INCREDIBLY ACCURATE AT LONG DISTANCES
- DRAMATICALLY REDUCE THE TIME NEEDED TO TAKE THE SHOT
- ALL CURRENT SETTINGS AND SUGGESTED ADJUSTMENTS VISIBLE IN DISPLAY
- ONCE ACQUIRED, YOU NEVER LOOSE SIGHT OF YOUR TARGET
- INNOVATIVE BUT YET RUGGED, RELIABLE AND INCREDIBLY PRECISE

## PRECISE WINDAGE AND ELEVATION ADJUSTMENT

Easy and immediate for repeated accuracy, with click-by-click feedback you can hear and feel every small change. Second rotation indicator included. Turret adjustment is shown in the display.

## UNMATCHED OPTICAL QUALITY

Military grade optics, legendary Steiner coating, world renowned ruggedness for an incredibly accurate and high tech riflescope that will never fail you.

## MENU KEY PANEL

The user interface is very intuitive and easy to use. Soft touch buttons take the user through the quick and easy set-up.

## BATTERY SLOT

The M7Xi IFS is powered by a simple AA battery. AA batteries are durable, reliable and easy to find anywhere in the world.

## SENSOR SUITE

Sensors provide real time input for temperature, barometric air pressure and inclination.

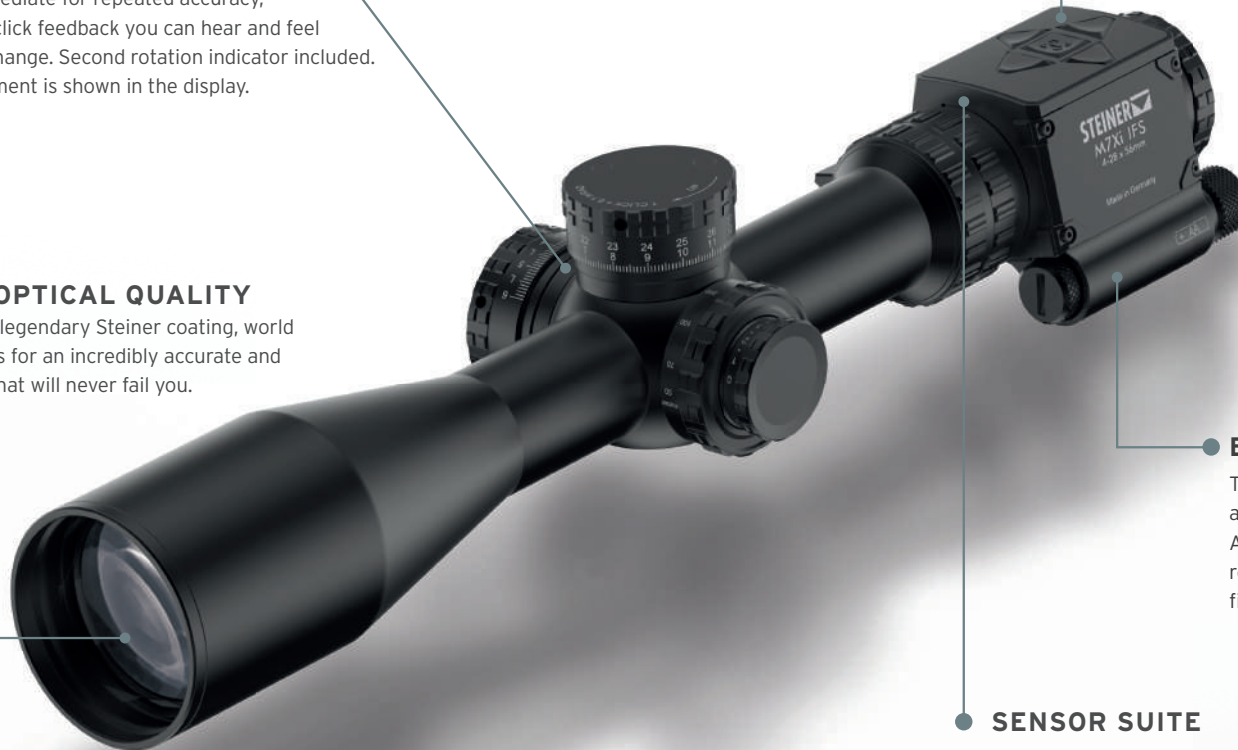

**AUTOMATICALLY CALCULATE ELEVATION SETTINGS**

The M7Xi IFS provides the optimal firing solution setting for any given distance, bullet specifications, temperature and altitude. This firing solution will automatically adjust with changes in the elevation turret.

**INCLINATION INDICATOR**

Visible in the display, the live inclination level eliminates shooting error due to cant.

**PERFECT POINT OF IMPACT**

The M7Xi IFS and M8Xi IFS automatically adjusts the reticle position using the provided environmental information. In a matter of seconds, it delivers the perfect point of impact.

**TARGET DISTANCE**

Simply rotate the elevation adjustment turret until the distance shown in display matches the distance of the target.

**WINDAGE**

Actual windage settings.

**SUGGESTED IDEAL WINDAGE SETTINGS**

Based on distance, bullet specifications, temperature and altitude, the M7Xi IFS suggests the ideal windage setting. Just rotate the windage adjustment until it matches the indicated setting.

**WIND SPEED AND DIRECTION**

Indicated wind speed and direction are shown as well.

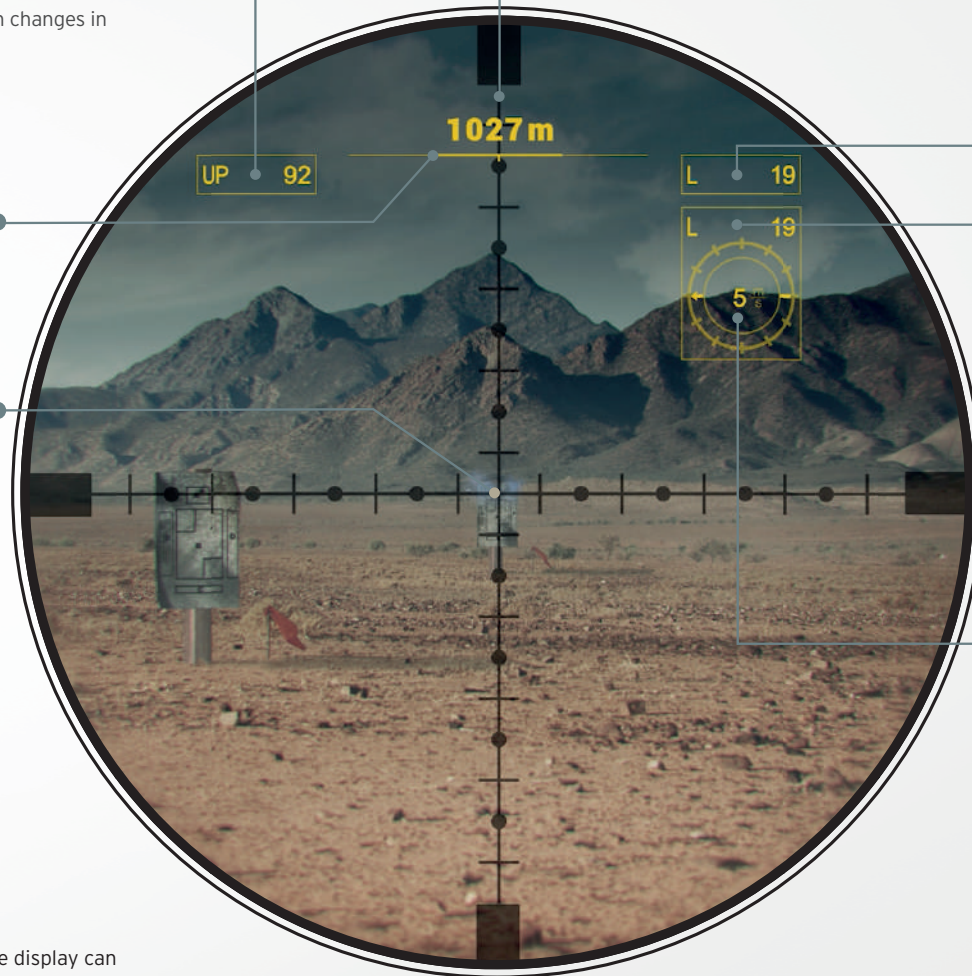

**STEINER Connect App**



The display can be 100% customized using the IFS App. Simply, download the app to set up your rifle scope directly from your phone via blue-tooth.

**THE M7XI IFS AND M8XI IFS DISPLAY IS 100% CUSTOMIZABLE.**

**KEEP THE INFORMATION THAT IS MOST IMPORTANT TO YOU IN YOUR FIELD OF VIEW TO CREATE A UNIQUE SHOOTING EXPERIENCE UNIQUE.**

## M7Xi 4-28X56



The 7x zoom gives the operator more flexibility and a higher resolution for all distances while the large field of view and the outstanding optical quality create a perfect overview of the surroundings at all times.

Item No. 8723000226

TUBE DIAMETER 34 mm | LENGTH 387 mm | WEIGHT 950 g

**NEW**

## M7Xi 2.9-20X50



Steiner introduces a new model for the successful and universally applicable M series. Especially the high detail recognition and optical quality due to the magnification of up to 20x is appreciated by special forces all over the world and enables a reliable hit rate on Targets up to 1,500 m away.

Item No. 8716008421

TUBE DIAMETER 34 mm | LENGTH 352 mm | WEIGHT 920 g

## M8Xi 1-8X24



The short overall length of the scope creates more rail space for clip-on devices (e.g. thermal imaging or night vision devices) for superior operational capabilities in any situation.

Item No. 8723000126

TUBE DIAMETER 34 mm | LENGTH 260 mm | WEIGHT 650 g

Based on the outstanding success of the **M5Xi** - used today by Special Forces around the globe - Steiner sets a new benchmark with the ultimate long-range riflescope **M7Xi 4-28x56** with a 7x zoom and an impressive field of view (1.42-9 m at 100 m). The ultimate DMR riflescope **M8Xi 1-8x24** offers an 8x zoom, which gives the operator more flexibility and a higher resolution from close quarter to mid-range scenarios. The new Steiner **M7Xi/M8Xi Series** guarantees outstanding reliability, water proofness and withstands shocks up to 900Gs.

### M7Xi/M8Xi OVERALL FEATURES

- The **SHORT OVERALL LENGTH** of the scope creates more rail space for clip-on devices (e.g. thermal imaging or night vision devices) for superior operational capabilities in any combat situation.
- **LOW PROFILE TURRETS** provide outstanding situational awareness and additional mounting options for add-ons and accessories.
- **PRECISE WINDAGE/ELEVATION ADJUSTMENT** is easy and accurate for repeatable accuracy, with tactile click-by-click feedback you can hear and feel.
- **ILLUMINATED RETICLE** with a brilliant image and a light transmission of more than 94%.
- **HIGH PERFORMANCE OPTICS** with repeatable and precise working mechanics.
- **EXTREME RUGGEDNESS AND RELIABILITY** achieved through durable materials and reliable design. A sturdy 34mm tube provides reliability and more space for windage and elevation adjustments for longer shots.
- **WATERPROOF AND SHOCKPROOF**  
The M7Xi is waterproof up to 20 meters with a functional range of -46°C to +64°C. It is rugged enough to withstand impact testing to 900Gs on all optical and electronic components.
- **RETICLE VARIETY**  
The new M7Xi is available with MSR2, G2B, TRMoR3 reticle.  
The new M8Xi is available with DMR8i reticle.



# M7Xi / M8Xi

## THE ULTIMATE LONG-RANGE-RIFLESCOPE

New benchmarks within the legendary  
Steiner ruggedness



10 YEAR\*  
WARRANTY

STEINER-OPTIK



M5Xi 5-25X56

The 3-15x is the perfect compromise of compact size and long-range performance. It provides outstanding visibility even in lowest light conditions combined with highest precision, accuracy and reliability.

Item No. 8707000101

TUBE DIAMETER 34 mm | LENGTH 365 mm | WEIGHT 920 g

The **M5Xi SERIES** offers ambitious hunters and sport shooters maximum performance even under toughest conditions. The high-grip, precise and accurate reticle adjustment offers, in combination with fine and detailed special reticles, many possibilities for every area of application. The **M5Xi** has been developed in close cooperation with international special forces mainly for rigorous demands of military missions around the globe. It has been tested in field operations under the toughest conditions by special forces, which is why it was even selected for the G29 of the Special Commando Forces of the Germany Army (KSK der Bundeswehr). The **M5Xi RIFLESCOPE SERIES** from STEINER sets new standards in terms of performance, quality and reliability.

..... **M5Xi**  
**OVERALL FEATURES** .....

- **5X ZOOM** provides maximum range at the high end, wider field of view at the low end, and eliminates any tunneling effect.
- **HIGH PERFORMANCE OPTICS** for 94% + light transmission to ensure optimal performance and better contrast in low light.
- **ILLUMINATED RETICLE** with seven night and four day levels with two "OFF" positions at each end, and quick standby levels between each for fast return setting.
- **OPTIMIZED EXTERIOR DESIGN** with larger, positive grip elevation, windage, parallax and illumination knobs and nonslip diopter and magnification adjustment.
- **PRECISE WINDAGE/ELEVATION ADJUSTMENT** is easy and accurate for repeatable accuracy, with tactile click-by-click feedback you can hear and feel.
- **DUOSCALE** - patented elevation adjustment with second-rotation scale that's hidden when inactive.
- **EXTREME RUGGEDNESS** engineered according to the highest military standards, rugged enough to withstand impact testing to 900Gs on all optical and electronic components. Water Pressure Proofness to 2 m. No dust, dirt or moisture can penetrate inside. Fogging or formation of condensation on the inside is completely eliminated by the STEINER Nitrogen-Pressure-Filling. Temperatures of -25 °C to +65 °C will not adversely affect the functionality.
- **RETICLE VARIETY**  
The M5Xi is available with G2B, MSR2, TReMoR3 and B4I reticle.



STEINER-OPTIK



# M5Xi

**BUILT IN GERMANY.  
DESIGNED FOR THE WORLD.**

The M5Xi riflescope series from STEINER sets new benchmarks in terms of performance, quality and reliability.



10 YEAR  
WARRANTY\*

STEINER-OPTIK

SHOOTING

41



# 4X32 S432

The large eye box together with the excellent illumination settings (Rotary Digital Control) allows the operator to be effective in any environment.

Item No. 8794900103  
MAGNIFICATION 4x | FIELD OF VIEW 11,8m | LENGTH 143mm | WEIGHT 640g



# 3X32 S332

The unmatched field of view (14,1 m) guarantees perfect perception of your surroundings at all times while the large eye relief (more than 80 mm) allows comfortable positioning in every situation.

Item No. 8793900103  
MAGNIFICATION 3x | FIELD OF VIEW 14,8m | LENGTH 142mm | WEIGHT 590g



Field of view market standard

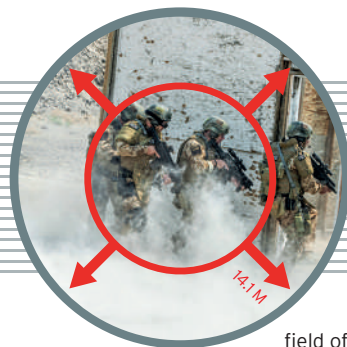

S332 field of view

The Steiner **S332** (3x zoom) and **S432** (4x zoom) are designed and engineered to be the best sights in the market due to the combination of optical quality, field of view, eye relief and a large eye box. The **S-SERIES** provides enhanced accuracy and quick target acquisition in a compact size with a bright and brilliant optical quality. They are easy to mount and simple to use becoming the most effective and convenient sights in the market.

### S-SERIES OVERALL FEATURES

- **3X OR 4X MAGNIFICATION TARGET ACQUISITION UP TO 800m**
- **VERY LARGE FIELD OF VIEW (S332: 14,1m; S432: 11,8m)** guarantees perfect perception of your surroundings.
- **LARGE EYE RELIEF** (= 80 mm) ensures comfortable handling in every situation.
- **VERY LARGE EYE BOX** combined with the excellent illumination settings (Rotary Digital Control) ensures an effective use of the sight under every condition.
- **OUTSTANDING ILLUMINATION SETTINGS**
- **DIOPTER SETTING FROM -3 TO +3**
- **100% FOG-PROOF WITH NITROGEN FILLING**
- **WATERPROOF AND SUBMERSIBLE UP TO 10m**
- **SHOCKPROOF UP TO 900 Gs**
- **GERMAN PRECISION OPTICS**
- **M-LOK MOUNTING SYSTEM**
- **RUGGED CONSTRUCTION**
- **RELIABLE MECHANICS**
- **SIMPLE AND EASY TO USE**
- **FLIP-UP CAPS AND SPACERS INCLUDED**
- **RETICLE AVAILABLE FOR 5.56 AND 7.62 CAL AND P7TR**



# S432/S332

## ENHANCED ACCURACY AND QUICK TARGET ACQUISITION

Designed to never fail in any situation.



10 YEAR\*  
WARRANTY

STEINER-OPTIK

SHOOTING

43



The 5x magnification enables precise use for shooting distances up to 600 m

Item No. 8798900103

MAGNIFICATION 5x | FIELD OF VIEW 6,3m | LENGTH 144mm | WEIGHT 500g



The 4x magnification makes the T432 the perfect all-rounder for short and medium distances.

Item No. 8797900103

MAGNIFICATION 4x | FIELD OF VIEW 7,9m | LENGTH 129mm | WEIGHT 470g



The 3x magnification gives the shooter an extremely large field of view and makes the T332, with its short design and low weight, universally applicable.

Item No. 8796900103

MAGNIFICATION 3x | FIELD OF VIEW 10,5m | LENGTH 122mm | WEIGHT 450g

The Steiner **T-SIGHTS** are tough, compact optics especially suited for AR platforms. Due to the optional 3x, 4x or 5x magnification paired with the illuminated STEINER Rapid Dot Reticle, the user is enabled to quickly acquire fast moving targets as well as close-up targets.

The **T-SIGHTS** are very short and lightweight and thanks to the rubber armoring they are increased in ruggedness. They are highly reliable, tough, shockproof, and waterproof (submersible up to 5 meters) and are fully adjustable up to +/- 50 MOA for elevation and windage.

The Steiner **T-SIGHTS** are waterproof, shockproof, fog proof with fully multi-coated lenses for brightness and clarity.

### T-SERIES OVERALL FEATURES

- **3X, 4X OR 5X MAGNIFICATION** for targeting out to 600 meters.
- **SHORT AND LIGHT WEIGHT:** Compact optics designed specifically for use on AR platforms.
- **OUTSTANDING RUGGEDNESS:** The T-Series is very short and lightweight and thanks to the rubber armoring they are in increased in ruggedness. They are highly reliable, tough, shockproof, and waterproof (submersible up to 10 meters) and are fully adjustable up to +/- 60 MOA for elevation and windage.
- **FULLY ILLUMINATED AND BRIGHT RETICLE**  
The Steiner T-Series provide a fast, clear aiming point in all light conditions with a fully illuminated ballistic reticle with 10 brightness settings for day & night operation.
- **PICATINNY BASE AT THE TOP**  
The T-Series adapts to all MIL -STD 1913 (Picatinny) rails and come with a picatinny base at the top that helps in mounting auxiliary sight for CQB operation.
- **100% FOG-PROOF WITH NITROGEN FILLING**
- **WATERPROOF AND SUBMERSIBLE UP TO 5m**
- **SHOCKPROOF UP TO 600 GS**
- **RUGGED CONSTRUCTION**
- **RELIABLE MECHANICS**
- **SIMPLE AND EASY TO USE**
- **FLIP-UP CAPS AND SPACERS INCLUDED**
- **RETICLE AVAILABLE FOR 5.56 AND 7.62 CAL**



STEINER-OPTIK

# T536/T432/T332

**COMPACT, LIGHTWEIGHT AND  
OUTSTANDING IN RUGGEDNESS**

Functional design for universal use



**10 YEAR\***  
WARRANTY

STEINER-OPTIK



**NEW**

# MPS

## MICRO PISTOL SIGHT

Item No. 870000025

MAGNIFICATION 1x | WEIGHT 58g (94g with adaptor) | WIDTH 31.5mm

The **MICRO PISTOL SIGHT (MPS)** is incredibly compact, and its ruggedness, enhanced by extra side wall, is up to the highest standards. Its closed design makes it perfect for any weather condition and reliable in the toughest environment.

..... **MPS OVERALL FEATURES** .....

- **STEINER LEGENDARY RUGGEDNESS:** The MPS is completely sealed, dustproof and water pressure-tight, making it particularly reliable.
- **COMPACT SIZE:** Its short size avoids any "tunnel-vision" while the low weight allows a perfect use.
- **BRIGHT DOT:** The brightness of the dot can be easily set and changed thanks to the ergonomics button on the side of the product.
- **EASY TO HANDLE:** The battery run time puts the MPS on top of its class and the easily accessible battery compartment allows the battery change without removing the MPS from the gun.
- **WIDE FIELD OF VIEW:** The low magnification offers an field of view and a parallax-free function at ranges from 10 to 150 meters.
- **MOUNTING OPTIONS:** The MPS is easily mountable on any gun Docter system compatible while most other manufacturer adaptors are available in the market.
- **ADAPTOR PLATE FOR DOCTER SYSTEM**



### 3,3 MOA

The 3,3 MOA dot allows fast and smooth target acquisition in any condition.



# MICRO PISTOL SIGHT

NEW



[ORIGINAL SIZE]

## COMPACT PRECISE RUGGED.

In any situation, no matter how stressful, you can always rely on your Steiner MPS.

10 YEAR\*  
WARRANTY

STEINER-OPTIK

SHOOTING

47

# ADVENTURE

## BUILT FOR A LIFETIME OF EXCEPTIONAL EXPERIENCES

You pass this way but once. Make sure you see it clearly: all the colour and contrast, every breathtaking detail, all laid out with depth and clarity only Steiner's world-class optical technology and adventure-loving construction can provide. Every hike, cruise, outing and event has its own unforgettable high point. Make the most of it with the best companion you could have along: Steiner Outdoor binoculars.

WILDLIFE  
SKYHAWK 4.0  
BLUHORIZONS  
SAFARI ULTRASHARP









# 10X42 WILDLIFE 10X42

The 10x42 with 10 times magnification for the best observation of little details at long distances.

Item No. 2325

MAGNIFICATION 10x | FIELD OF VIEW 108m | WEIGHT 716g



# 8X42 WILDLIFE 8X42

The 8x42 with a wider field of view for a more stable image also when you are moving.

Item No. 2324

MAGNIFICATION 8x | FIELD OF VIEW 125m | WEIGHT 725g

The new **WILDLIFE BINOCULARS SERIES** perfectly represents everything Steiner stands for: innovation, extreme ruggedness, usability, high optics quality and outstanding mechanical reliability. The New Steiner **WILDLIFE** is designed and developed for the ambitious outdoorsmen and outdoorswomen who cannot accept compromise when it comes to equipment. When the weather becomes a threat, you need your equipment to be reliable. The new design and re-engineered optics make the new **WILDLIFE** a companion you can always trust, especially in the most adverse conditions.

### WILDLIFE OVERALL FEATURES

- **STEINER HIGH-DEFINITION-OPTICS** deliver razor-sharp images with high image contrast and brilliant colour definition. First-class coating technology and light transmission always provide clear and bright images, even in poor light conditions.
- **FAST-CLOSE-FOCUS** central focusing wheel requires minimal, stepless rotation for quick absolute sharpness from close-up to infinity- comfortable, easy to use.
- **DISTANCE-CONTROL-SYSTEM** is the fastest focussing system in the market and enables pre-setting of observation distance and sharp focussing by one simple turn of the non-slip XL-focussing wheel. (10x42 and 8x42 Models)
- **XL FIELD OF VIEW** ensures an overview of search and observations activities.
- **ERGONOMIC DESIGN** ensures extreme handiness and compactness.
- **EXTREME RUGGEDNESS** with durable polycarbonate Makrolon housing, Water Pressure Proofness to 3m and the Nitrogen-Pressure-Filling via the two-way-valve-system against fogging up inside the optics at a temperature range between -20°C to +70°C. Non-slip NBR-Longlife rubber armour protection resists oil, acid or adverse weather. Impervious to harsh conditions for generations of trusted use.
- **ERGONOMIC EYECUPS** made of skin-friendly, non-ageing silicone provide observation comfort and protection against incident light and draught. Simply folded down for use with eyeglasses.
- **CLICLOC-STRAP ATTACHMENT SYSTEM** attaches and releases neck strap with instant, push-button ease, and keeps binoculars hanging straight and action-ready.



# 10.5X28 WILDLIFE 10.5X28

The 10.5x magnification offers more power and performance without sacrificing weight for detailed nature studies. The light yield in poor weather conditions or at dusk is astounding and will amaze you in all situations.

Item No. 2323

MAGNIFICATION 10,5x | FIELD OF VIEW 88m | WEIGHT 344g



# 8X24 WILDLIFE 8X24

The small flyweight with 8x magnification is the ideal companion for hiking and mountain/rock climbing. Great optical performance, large field of view and extremely rugged.

Item No. 2321

MAGNIFICATION 8x | FIELD OF VIEW 114m | WEIGHT 346g



STEINER-OPTIK

**WILDLIFE**



## DON'T SETTLE FOR COMPROMISE

unfailingly reliable, field-tested binoculars to deliver superbly bright, accurate images right to the edge in any situation.

**30** YEAR  
WARRANTY\*

STEINER-OPTIK

ADVENTURE

51



# SKYHAWK 4.0 10X42

From close up to far away, this mid-size SkyHawk 4.0 10x42 delivers bright, crisp images with a bright 42mm aperture. 10x power for great long-range detail, perfect for wide-open country and hilly regions.

Item No. 2339

MAGNIFICATION 10x | FIELD OF VIEW 108m | WEIGHT 745g



# SKYHAWK 4.0 8X42

It is an all-around favourite without added bulk or weight. Versatile enough for observation even in difficult weather conditions. Large field of view and comfortable, calm handling.

Item No. 2338

MAGNIFICATION 8x | FIELD OF VIEW 125m | WEIGHT 750g

Anyone who keeps a close eye on nature experiences a unique fascination. This is exactly what we have developed the **SKYHAWK 4.0** for: to observe nature clear and sharp at any times. The new **SKYHAWK SERIES** offers a unique optic experience and impresses of course with the already legendary STEINER ruggedness.

## SKYHAWK 4.0 OVERALL FEATURES

- **STEINER HIGH-CONTRAST-OPTICS** provide bright views, accurate colour and clear, brilliant 3D-images with high contour sharpness for exceptional performance around outdoor activities up to close range of 2m.
- **FAST-CLOSE-FOCUS** central focusing wheel requires minimal, stepless rotation for quick absolute sharpness from close-up to infinity - comfortable, easy to use.
- **DISTANCE-CONTROL-SYSTEM** enables pre-setting of observation distance and sharp focusing by one simple turn of the non-slip XL-focusing wheel.
- **OUTSTANDING RUGGEDNESS** with durable polycarbonate Makrolon housing, Water Pressure Proofness to 3m and the Nitrogen-Pressure-Filling into the optic against fogging up inside at temperature range between -20°C to +70°C. Non-slip NBR-Longlife rubber armour protection resists oil, acid or adverse weather. Impervious to harsh conditions for generations of trusted use.
- **ERGONOMIC DESIGN** providing comfortable long-term observations. Ergonomic pliable eyecups made of soft, skin-friendly and non-ageing silicone protect against incident light and draught. Simply to be folded down for use with eyeglasses. Finger depressions for an excellent grip.
- **LIGHTWEIGHT** roof prism design has less bulk to fit into your pack and stay out of the way while observing.
- **EXTENSIVE ACCESSORIES** with case, neoprene-carrying strap, rain protection cap and objective covers.



# SKYHAWK 4.0 10X32

10x magnification for long distance observation that reveals a fascinating wealth of natural details. Provides ample power and superb optical performance.

Item No. 2337

MAGNIFICATION 10x | FIELD OF VIEW 118m | WEIGHT 600g



# SKYHAWK 4.0 8X32

8x32 model is ideal for mobile bird and nature watchers who need the versatility of lightweight, good magnification and wide view, also for long-term observations.

Item No. 2336

MAGNIFICATION 8x | FIELD OF VIEW 133m | WEIGHT 580g



STEINER-OPTIK

# SKYHAWK 4.0



**FAST. CLOSE. SHARP.**

Feel nature with your eyes.

**10 YEAR\***  
WARRANTY

STEINER-OPTIK

ADVENTURE

53



**NEW**

## BLUHORIZONS 10X42

The 10x magnification enables high detail recognition and the large 42mm lens diameter ensures a clear view, even in low light conditions.

Item No. 2345

MAGNIFICATION 10x | FIELD OF VIEW 100m | WEIGHT XXXg



**NEW**

## BLUHORIZONS 8X32

The good combination of weight, size and observation comfort make the 8x32 a perfect all-rounder between compact and full-size binoculars.

Item No. 2344

MAGNIFICATION 8x | FIELD OF VIEW 118m | WEIGHT XXXg

Specially designed for all outdoor adventurers, the **BLUHORIZONS** not only fits in almost every pocket, it is also lightweight and extremely rugged. It is the world's first and only binocular with phototropic lenses. This means that it automatically adapts to the lighting conditions so that you always have optimum vision even in bright sunshine or light reflections.

### BLUHORIZONS OVERALL FEATURES

- **AUTOBRIGHT TECHNOLOGY** automatically optimises the light transmission of the lens for maximum clarity in bright conditions. No reflections or glare from water, snow, sand or the sky. No squinting, no guessing and no eye strain. Simply a perfect image.
- **EYES PROTECTION:** Steiner's exclusive Autobright sunlight-adaptive lens technology automatically adjusts brightness to provide the best view in any lighting situation. Whether the sun is just below the horizon, shining directly overhead, or bouncing off water or snow from all angles, BluHorizons are designed to pick up the right amount of light and reduce glare for optimal visibility.
- **FAST-CLOSE-FOCUS:** minimal, stepless focusing on the centre drive for fast, razor-sharp detail from close-up to infinity. Comfortable and easy to use.
- **EXTREME RUGGEDNESS** due to durable housing, watertightness and functionality in the temperature range from -20 °C to +70 °C. Non-slip NBR longlife rubber armouring resists oil, acid and weathering.
- **COMPACT AND LIGHTWEIGHT DESIGN** ensures razor-sharp images in the smallest of spaces, so you can take your binoculars with you wherever you go.
- **ERGONOMIC EYECUPS** made of non-irritant, non-ageing silicone provide a high degree of viewing comfort and protection against incident light and draughts. Easy to fold over for use with glasses.
- **EXTENSIVE ACCESSORIES** with a comfortable carrying strap and a unique, multi-functional neoprene carrying case.



**NEW**

## BLUHORIZONS 10X26

With only 310g the 10x26 captivates with a high magnification and brings every object directly before your eyes. Its compactness makes it a constant companion in any luggage.

Item No. 2044

MAGNIFICATION 10x | FIELD OF VIEW 98m | WEIGHT 310g



**NEW**

## BLUHORIZONS 8X22

At just 305g, the compact lightweight fits in any pocket and is ready to go when you need it. The ideal companion for travelers with light luggage.

Item No. 2043

MAGNIFICATION 8x | FIELD OF VIEW 125m | WEIGHT 305g



STEINER-OPTIK

# BLUHORIZONS NEW



## AUTOBRIGHT TECHNOLOGY

Sun protection factor for the eyes.



STEINER-OPTIK



Item No. 2308

## SAFARI ULTRASHARP 10X42

# 10X42

Versatile 10x magnification and a bright 42mm objective for maximum detail recognition at both close-range and greater distances. For an ambitious entry into outdoor applications.

MAGNIFICATION 10x | FIELD OF VIEW 100m | WEIGHT 720g



Item No. 4477

## SAFARI ULTRASHARP 10X26

# 10X26

10x magnification shows you more detail from farther away, perfect for sports events and wildlife observation. Compact, lightweight and multifunctional.

MAGNIFICATION 10x | FIELD OF VIEW 101m | WEIGHT 297g



Item No. 4457

## SAFARI ULTRASHARP 8X22

# 8X22

A featherlight, compact sport optic with 8x magnification that looks great, fits your pack, pocket or purse, and is your constant companion for quick use.

MAGNIFICATION 8x | FIELD OF VIEW 125m | WEIGHT 228g

Every traveller, sports enthusiast, and active participant in anything needs a good pair of binoculars to see, understand and enjoy more. These are the ones you need: lightweight design, contemporary styling, comfort and simplicity, and a choice of power and capabilities let you pick the optics that fit you perfectly. Steiner's world-renowned image clarity, accurate colour and field-proven toughness ensure maximum performance from your optics - and more pleasure from your pursuit of adventure.

### SAFARI ULTRASHARP OVERALL FEATURES

- **STEINER HIGH-CONTRAST-OPTICS** provide bright views, accurate colour and clear, brilliant 3D-images with high contour sharpness for exceptional performance around outdoor activities.
- **FAST-CLOSE-FOCUS** central focusing wheel requires minimal, stepless rotation for quick absolute sharpness from close-up to infinity- comfortable, easy to use.
- **LIGHTWEIGHT, ERGONOMIC DESIGN** ensures sharp, crisp images in minimal space, so you can keep your optics anywhere.
- **EXTREME RUGGEDNESS** with durable construction, water/fogproofing you can trust to stand up to any cold or wet condition at a temperature range between -20°C to +70°C. Non-slip NBR-Longlife rubber armour protection resists oil, acid or adverse weather.
- **ERGONOMIC EYECUPS** made of skin-friendly, non-ageing silicone provide observation comfort and protection against incident light and draught. Simply folded down for use with eyeglasses (except 10x42).
- **CLICLOC-STRAP ATTACHMENT SYSTEM** attaches and releases neck strap with instant, push-button ease, and keeps binoculars hanging straight and action-ready (10x42).





# SAFARI ULTRASHARP



[ORIGINAL SIZE]

## COMPACT AND CAPABLE IS NO LONGER A CONTRADICTION

From compact to full-size, optics get you closer to things you enjoy most: photo safaris, ocean cruises, concerts, sports events, and more. Wherever life takes you, these are the perfect companions.

10 YEAR  
WARRANTY\*

STEINER-OPTIK

# MARINE

## MOST OF THE WORLD IS WATER. ALL OF IT IS HOME TO STEINER.

It's not just wet. It's a whole different world. Fogbound mornings, afternoons of glaring sun and salt spray, nights like floating on ink. Always in motion, temperatures all over the board, distances that challenge land-bound perceptions. Steiner marine optics were built for this: waterproof, corrosion-proof, always crystal-clear, with special coatings, construction and capabilities specifically created for a water-borne life - from the inventor of compass binoculars.

COMMANDER GLOBAL  
COMMANDER LRF  
COMMANDER  
NAVIGATOR PRO





# THE COMMANDER

UNBREAKABLE. UNMATCHED. INDISPENSABLE.



STEINER-OPTIK

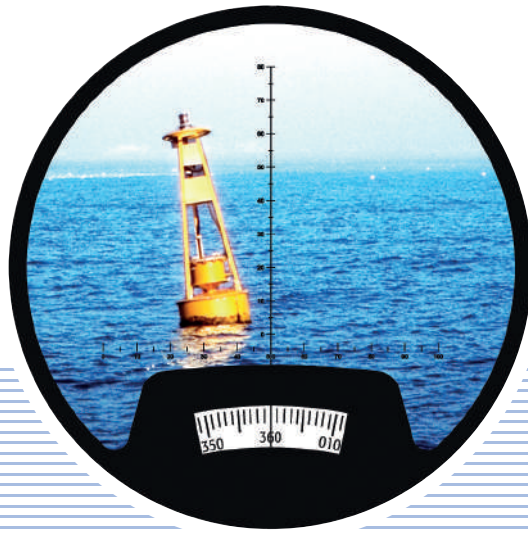

## LARGEST AND MOST PRECISE COMPASS

With a 40 mm-diameter, the large integrated HD-Stabilized compass of the Commander 7x50c is a market leader. The bearing works thanks to the size of the compass and the optimized fluid damping quickly, accurately and reliably, even under extreme conditions. A user-friendly illumination and a precision reticle for exact size or distance calculation round off the high performance compass and give you that little bit of extra security on high seas. Rely on your safest navigational equipment on board.



## XL FIELD OF VIEW

Rounding out the optical performance of the Commander with the best possible overview in any situation. The field of view was maximized by around 12% to 145m / 1000m. Significantly brighter, clearer images will thus provide perfect safety at sea.

## THE COMMANDER AMONG BINOCULARS

The new Commander Series is unmatched in terms of technology and innovation. With its razor-sharp High-Definition-Optics and the most accurate analog compass as well as the optimum combination of functionality, ruggedness, precision and comfort the Commander binoculars define a new class. For the highest ambitions on the water, where there is no compromise.



# 7X50c

## COMMANDER 7X50c

Additionally integrates a fluid-dampened, HD stabilized illuminated compass with ranging reticle, creating one accurate and invaluable navigation tool.

Item No. 2305

MAGNIFICATION 7x | FIELD OF VIEW  $\geq 145$ m | WEIGHT 1190g



# 7X50

## COMMANDER 7X50

Delivers exceptional image clarity, sharp edge-to-edge-definition and contrast, as well as high light transmission for navigating in low light or fog.

Item No. 2304

MAGNIFICATION 7x | FIELD OF VIEW  $\geq 145$ m | WEIGHT 1090g



The new **COMMANDER SERIES** is unmatched in terms of technology and innovation. With its razor-sharp High-Definition-Optics and the most accurate analog compass as well as the optimum combination of functionality, ruggedness, precision and comfort the Commander binoculars define a new class. For the highest ambitions on the water, where there is no compromise.

### ..... COMMANDER OVERALL FEATURES .....

- **STEINER HIGH-DEFINITION-OPTICS** for clear images in full contrast with maximum resolution.
- **STEINER DIAMOND-MARINE-COATING** is a unique formula that reduces glare, enhances clarity and maximizes light transmission for optimized viewing in hazy light and after dark.
- Top performing optics by **SPORTS-AUTO-FOCUS SYSTEM** that lets you focus each eyepiece to your vision once, then keeps razor sharp from 20m to infinity, no more chasing focus on moving targets, 3D-images and the specification 7x magnification and 50mm objective produce a wide, stable view and bright, clear images in all conditions.
- **XL-FIELD OF VIEW WITH 145 M/1000M** for the utmost overview in every situation.
- **LARGEST AND MOST PRECISE HD-STABILIZED COMPASS** with user-friendly illumination and integrated precision reticle.
- **LEGENDARY RUGGEDNESS** with durable polycarbonate Makrolon housing that withstands 11G of impact, Floating Prism System to absorb severe shock, impact and abuse without damage, Water Pressure Proofness to 10m, Nitrogen-Pressure-Filling into the optic against fogging up inside at temperature range between  $-40^{\circ}\text{C}$  to  $+80^{\circ}\text{C}$  and the protective, hydrophobic Steiner Nano-Protection on the lenses making water sheeting off and dirt, dust, snow are repellent for easy cleaning and clear view.
- **COMFORT-BALANCE-SYSTEM** with NBR-Long Life rubber armouring (for better grip, protection and slip resistance on board), Steiner ComfortGrip thumb rests, versatile ErgoFlex Eyecups and the **unique Memory-Ocular** saving personal diopter settings.
- **HIGH-END ACCESSORIES** with hardcase, comfortably padded, 3M-ClickLoc floating strap, ClickLoc neoprene-carrying strap for instant, push-button ease, rain protection cap and objective covers.



STEINER-OPTIK

# COMMANDER



**UNBREAKABLE.  
UNMATCHED.  
INDISPENSABLE.**

The new Commander: Unmatched high class and precise, indestructible robust and indispensable reliable.

**30 YEAR\***  
WARRANTY

STEINER-OPTIK

MARINE

63



**NEW**

## NAVIGATOR 7X50c

An incredibly bright and detailed image paired with the largest compass in its class.

Item No. 23430920

MAGNIFICATION 7x | FIELD OF VIEW  $\geq 128$  m | WEIGHT 1115g



**NEW**

## NAVIGATOR 7X50

With 50 mm lens diameter a bright, brilliant image even in twilight.

Item No. 23420900

MAGNIFICATION 7x | FIELD OF VIEW  $\geq 128$  m | WEIGHT 1040g

The new **NAVIGATOR** takes STEINER's popular marine series into a new generation with innovative product features. Handling is dramatically improved thanks to the new "Open-Bridge-System", while the texturing on the body allows for comfortable and strong grip in any situation. The STEINER Auto-Focus guarantees always sharp images even while handling the product with one hand. All models are reliable under the most adverse weather conditions and keep the promise of legendary STEINER ruggedness.

### NAVIGATOR OVERALL FEATURES

- **STEINER HIGH-CONTRAST-OPTICS** Delivers bright, high-contrast images, high contour sharpness, and brilliant 3D viewing experiences with natural colour reproduction.
- **OPEN-BRIDGE-SYSTEM** Thanks to the "open bridge" the binoculars can now be gripped and held even more securely.
- **ENHANCED COMPASS DESIGN** The modified positioning of the lighting button makes the compass lighting even easier to operate.
- **IMPROVED FIELD OF VIEW** The further extended field of vision offers the best possible overview on the water.
- **STEINER AUTO-FOCUS** Once set, the STEINER Auto-Focus always delivers sharp images without refocusing.

- **SPECIAL RUBBER COATING TEXTURE**

The new, wave-like rubber coating texture ensures a secure grip on the binoculars and significantly improves wearing comfort.

- **ADVANCED ACCESSORIES**

- New carry bag, so your binoculars stay safe also during off-season
- Soft neoprene strap with new, universal attachment system
- Lens protection caps, Rain cover
- floating strap with 3M light stripes



**NEW**

## NAVIGATOR 7X30c

Compact and lightweight combined with integrated HD-stabilised compass.

Item No. 23410920

MAGNIFICATION 7x | FIELD OF VIEW  $\geq 128$  m | WEIGHT 530g



**NEW**

## NAVIGATOR 7X30

As an absolute lightweight, the perfect companion for spontaneous trips or shore excursions.

Item No. 23400900

MAGNIFICATION 7x | FIELD OF VIEW  $\geq 128$  m | WEIGHT 499g



# NAVIGATOR NEW



## TRUST IN TRUE PERFORMANCE

High-contrast-optics, extended field of view and optimised compass design, combined with intuitive handling, thanks to the new open-bridge-system

10 YEAR WARRANTY\*

STEINER-OPTIK

MARINE

65

# BINOCULARS

HUNTING THERMAL			
	Nighthunter H35	Nighthunter C35	Nighthunter S35
Item No.	8700000101	8700000102	8700000103
Detector Resolution	640 x 480 @ 12m	640 x 480 @ 12m	640 x 480 @ 12m
Focal length	35mm F1.0	35mm F1.0	35mm F1.0
Field of view at 100m	12,5 m x 9,4 m	12,5 m x 9,4 m	12,5 m x 9,4 m
System magnification	digital	-	-
Display	LCOS	OLED	LCOS
Resolution	1280 x 960 Pixel	800 x 600 Pixel	1024 x 768 Pixel
Output frame rate	50Hz	50Hz	50Hz
Screen size max.	22 inch	10,8 inch at 1m Distance	22 inch
Magnification	2 x	-	-
Video output format	mp4 / jpg	mp4 / jpg	mp4 / jpg
Temperature range	-10°C bis +50°C	-10°C bis +50°C	-10°C bis +50°C
Shock	30G	30G	30G
Waterproof	water resistant	water resistant	water resistant
Stadiametric Rangefinder	yes	yes	yes
PIP Function	yes	yes	yes
Color palettes	White hot / Black hot / adjustable Red hot / Iron / Blue hot	White hot / Black hot / adjustable Red hot / Iron / Blue hot	White hot / Black hot / adjustable Red hot / Iron / Blue hot
Calibration mode	Automatic	Automatic	Automatic
Stand-By Modus	yes	yes	yes
Weight	695 g	785 g	1043 g
Width	232 mm	177 mm	215 mm
Height	70 mm	95 mm	80 mm
Depth	72 mm	62 mm	85 mm
USB	TYP C (USB 2.0 Standard),	TYP C (USB 2.0 Standard),	TYP C (USB 2.0 Standard),
Video interface	Micro HDMI	Micro HDMI	Micro HDMI
WiFi	yes (Steiner-Connect-App)	yes (Steiner-Connect-App)	yes (Steiner-Connect-App)
Working time	≥ 4,5 hours	≥ 4,5 hours	≥ 4,5 hours
Accessories	Performance Bag, Power adapter 5 V DC,	Performance Bag, Power adapter 5 V DC,	Performance Bag, Power adapter 5 V DC,
Battery	Li-Ion Akku, 6000 mAh built-in	Li-Ion Akku, 3000 mAh changeable	Li-Ion Akku, 6000 mAh changeable
Warranty	2 years	2 years	2 years

	JAGD							ADVENTURE		
	Nighthunter 8x56	Ranger Xtreme 8x56	Ranger Xtreme 10x42	Ranger Xtreme 8x42	Ranger Xtreme 8x32	Observer 8x56	Observer 10x42	Observer 8x42	Wildlife 10x42	Wildlife 8x42
Item No.	2310	5118	5117	5116	5119	2335	2314	2313	2325	2324
Objektive diameter	56 mm	56 mm	42 mm	42 mm	32 mm	56 mm	42 mm	42 mm	42 mm	42 mm
Magnification	8 x	8 x	10 x	8 x	8 x	8 x	10 x	8 x	10 x	8 x
Weight	1090 g	1130 g	790 g	780 g	620 g	1130 g	706 g	696 g	716 g	725 g
Width	200 mm	142 mm	125 mm	125 mm	124 mm	144 mm	128 mm	128 mm	135 mm	135 mm
Height	212 mm	183 mm	147 mm	147 mm	128 mm	183 mm	148 mm	148 mm	165 mm	165 mm
Depth	74 mm	80 mm	63 mm	63 mm	60 mm	80 mm	65 mm	65 mm	60 mm	60 mm
Temperature range	-40°C to +80°C	-20°C to +80°C	-20°C to +80°C	-20°C to +80°C	-20°C to +80°C	-15°C to +55°C	-15°C to +55°C	-15°C to +55°C	-20°C to +80°C	-20°C to +80°C
Exit pupil	7,0 mm	7,0 mm	4,2 mm	5,3 mm	4,0 mm	7,0 mm	4,2 mm	5,3 mm	4,2 mm	5,3 mm
Luminosity	49	49	18	28	16	49	17,6	27,6	18	28
Twilight factor	21,2	21,2	20,5	18,3	16	21	20,5	18,3	20,5	18,3
Field of view at 1000 m	135 m	125 m	108 m	125 m	133 m	112 m	100 m	116 m	108 m	125 m
Focusing system	Sports-Auto-Focus	Fast-Close-Focus	Fast-Close-Focus	Fast-Close-Focus	Fast-Close-Focus	Fast-Close-Focus	Fast-Close-Focus	Fast-Close-Focus	Fast-Close-Focus	Fast-Close-Focus
Close focus range	-	2,3 m	1,9 m	1,9 m	1,9 m	2 m	2 m	2 m	2 m	2 m
High-Performance-Optics	High-Definition XP-Optics	High-Contrast	High-Contrast	High-Contrast	High-Contrast	High-Contrast	High-Contrast	High-Contrast	High-Definition	High-Definition
Nano-Protection	yes	-	-	-	-	-	-	-	-	-
Waterproof	up to 5 m	up to 3 m	up to 3 m	up to 3 m	up to 3 m	up to 1 m	yes	yes	up to 3 m	up to 3 m
Steiner Nitrogen-Pressure-System	by 2-way-valve technology	by 2-way-valve technology	by 2-way-valve technology	by 2-way-valve technology	by 2-way-valve technology	yes	-	-	by 2-way-valve technology	by 2-way-valve technology
Rubber armouring	NBR-Longlife	NBR-Longlife	NBR-Longlife	NBR-Longlife	NBR-Longlife	NBR-Longlife	NBR-Longlife	NBR-Longlife	NBR-Longlife/ComfortGrip	NBR-Longlife/ComfortGrip
Eyecups	ErgoFlex	Ergonomic Rotation Eyecup	Ergonomic Rotation Eyecup	Ergonomic Rotation Eyecup	Ergonomic Rotation Eyecup	Cylindrical Rotation Eyecup	Cylindrical Rotation Eyecup	Cylindrical Rotation Eyecup	Ergonomic Rotation Eyecup	Ergonomic Rotation Eyecup
Compass	-	-	-	-	-	-	-	-	-	-
Bearing	-	-	-	-	-	-	-	-	-	-
Carrying strap	Neoprene	Neoprene	Neoprene	Neoprene	Neoprene	Neoprene	Standard	Standard	Neoprene	Neoprene
Strap attachment	ClicLoc	ClicLoc	ClicLoc	ClicLoc	ClicLoc	Standard	Standard	Standard	ClicLoc	ClicLoc
Objektive cover	yes	yes	yes	yes	yes	yes	yes	yes	yes	yes
Rain protection cap	yes	yes	yes	yes	yes	yes	yes	yes	yes	yes
Carry case	yes	yes	yes	yes	yes	yes	yes	yes	yes	yes
Battery	-	-	-	-	-	-	-	-	-	-
Warranty	30 years	10 years	10 years	10 years	10 years	10 years	10 years	10 years	30 years	30 years



# SPECIFICATIONS

ADVENTURE													MARINE					
Wildlife 10.5x28	Wildlife 8x24	SkyHawk 4.0 10x42	SkyHawk 4.0 8x42	SkyHawk 4.0 10x32	SkyHawk 4.0 8x32	BluHorizons 10x42	BluHorizons 8x32	BluHorizons 10x26	BluHorizons 8x22	Safari UltraSharp 10x42	Safari UltraSharp 10x30 CF	Safari UltraSharp 8x30 CF	Commander 7x50 c	Commander 7x50	Navigator 7x50 c	Navigator 7x50	Navigator 7x30 c	Navigator 7x30
2323	2321	2339	2338	2337	2336	2345	2344	2044	2043	2308	4406	4405	2305	2304	23430920	23420900	23410920	23400900
28 mm	24 mm	42 mm	42 mm	32 mm	32 mm	42 mm	32 mm	26 mm	22 mm	42 mm	30 mm	30 mm	50 mm	50 mm	50 mm	50 mm	30 mm	30 mm
10,5 x	8 x	10 x	8 x	10 x	8 x	10 x	8 x	10 x	8 x	10 x	10 x	8 x	7x	7x	7x	7x	7x	7x
350 g	350 g	745 g	750 g	600 g	580 g	740 g	590 g	310 g	305 g	720 g	611 g	611 g	1190 g	1090 g	1115 g	1040 g	530 g	499 g
115 mm 130 mm 50 mm	115 mm 121 mm 50 mm	120 mm 147 mm 65 mm	122 mm 147 mm 65 mm	115 mm 127 mm 60 mm	115 mm 127 mm 60 mm	125 mm 147 mm 60 mm	118 mm 127 mm 58 mm	111 mm 114 mm 46 mm	111 mm 103 mm 44 mm	128 mm 148 mm 65 mm	166 mm 120 mm 57 mm	166 mm 120 mm 57 mm	206 mm 157 mm 96 mm	206 mm 157 mm 75 mm	208 mm 140 mm 87 mm	208 mm 140 mm 70 mm	165 mm 106 mm 62,5 mm	165 mm 106 mm 50 mm
-20 °C to +70 °C	-20 °C to +70 °C	-20 °C to +70 °C	-20 °C to +70 °C	-20 °C to +70 °C	-20 °C to +70 °C	-20 °C to +70 °C	-20 °C to +70 °C	-20 °C to +70 °C	-20 °C to +70 °C	-20 °C to +70 °C	-20 °C to +70 °C	-20 °C to +70 °C	-40 °C to +80 °C	-40 °C to +80 °C	-20 °C to +70 °C	-20 °C to +70 °C	-20 °C to +70 °C	-20 °C to +70 °C
2,7 mm	3,0 mm	4,2 mm	5,3 mm	3,2 mm	4,0 mm	4,2 mm	4,0 mm	2,6 mm	2,8 mm	4,2 mm	3,0 mm	3,8 mm	7,1 mm	7,1 mm	7,14 mm	7,14 mm	4,29 mm	4,29 mm
7	9	17,6	27,6	10,2	16,0	17,64	16,0	6,8	7,6	17,6	9,0	14,0	51,2	51,0	51,0	51,0	18,4	18,4
17,1	13,9	20,5	18,3	17,9	16,0	20,49	16,0	16,1	13,3	20,5	17,3	15,5	18,7	18,7	18,7	18,7	14,5	14,5
88 m	114 m	108 m	125 m	118 m	133 m	100 m	118 m	98 m	125 m	100 m	105 m	120 m	≥ 145 m	≥ 145 m	≥ 128 m	≥ 128 m	≥ 128 m	≥ 128 m
Fast-Close-Focus	Fast-Close-Focus	Fast-Close-Focus	Fast-Close-Focus	Fast-Close-Focus	Fast-Close-Focus	Fast-Close-Focus	Fast-Close-Focus	Fast-Close-Focus	Fast-Close-Focus	Fast-Close-Focus	Sports-Auto-Focus Plus	Sports-Auto-Focus Plus	Sports-Auto-Focus	Sports-Auto-Focus	Steiner-Auto-Focus	Steiner-Auto-Focus	Steiner-Auto-Focus	Steiner-Auto-Focus
2 m	2 m	2 m	2 m	2 m	2 m	2 m	2 m	2 m	2 m	2 m	2 m	2 m						
High-Definition	High-Definition	High-Contrast	High-Contrast	High-Contrast	High-Contrast	High-Contrast	High-Contrast	High-Contrast	High-Contrast	High-Contrast	High-Contrast	High-Contrast	High-Definition	High-Definition	High-Contrast	High-Contrast	High-Contrast	High-Contrast
-	-	-	-	-	-	-	-	-	-	-	-	-	yes	yes	-	-	-	-
up to 2 m	up to 2 m	up to 3 m	up to 3 m	up to 3 m	up to 3 m	yes	yes	yes	yes	yes	yes	yes	up to 10 m	up to 10 m	up to 5 m	up to 5 m	up to 5 m	up to 5 m
by 2-way-valve technology	by 2-way-valve technology	by 2-way-valve technology	by 2-way-valve technology	by 2-way-valve technology	by 2-way-valve technology	-	-	-	-	-	-	-	by 2-way-valve technology	by 2-way-valve technology	by 2-way-valve technology	by 2-way-valve technology	by 2-way-valve technology	by 2-way-valve technology
NBR-Longlife	NBR-Longlife	NBR-Longlife	NBR-Longlife	NBR-Longlife	NBR-Longlife	NBR-Longlife	NBR-Longlife	NBR-Longlife	NBR-Longlife	NBR-Longlife	NBR-Longlife	NBR-Longlife	NBR-Longlife	NBR-Longlife	NBR-Longlife	NBR-Longlife	NBR-Longlife	NBR-Longlife
ergonomic	ergonomic	Ergonomic Rotation Eyecup	Ergonomic Rotation Eyecup	Ergonomic Rotation Eyecup	Ergonomic Rotation Eyecup	Ergonomic Eyecup	Ergonomic Eyecup	Ergonomic Eyecup	Ergonomic Eyecup	Cylindrical Rotation Eyecup	ergonomic	ergonomic	ErgoFlex	ErgoFlex	Cylindric-soft	Cylindric-soft	Cylindric-soft	Cylindric-soft
-	-	-	-	-	-	-	-	-	-	-	-	-	High-Precision HD-stabilized	-	HD-stabilized	-	HD-stabilized	-
-	-	-	-	-	-	-	-	-	-	-	-	-	Precision Reticle	-	Bearing mark	-	Bearing mark	-
Neoprene	Neoprene	Neoprene	Neoprene	Neoprene	Neoprene	yes	yes	yes	yes	Comfort	Neoprene	Neoprene	Neoprene & floating strap	Neoprene & floating strap	Neoprene	Neoprene	Neoprene	Neoprene
ClicLoc	ClicLoc	Universal	Universal	Universal	Universal	Universal	Universal	Universal	Universal	ClicLoc	ClicLoc	ClicLoc	ClicLoc	ClicLoc	Standard	Standard	Standard	Standard
-	-	yes	yes	yes	yes	yes	yes	yes	yes	yes	yes	yes	yes	yes	yes	yes	yes	yes
yes	yes	yes	yes	yes	yes	yes	yes	yes	yes	yes	yes	yes	yes	yes	yes	yes	yes	yes
yes	yes	yes	yes	yes	yes	yes	yes	yes	yes	yes	yes	yes	yes	yes	yes	yes	yes	yes
-	-	-	-	-	-	-	-	-	-	-	-	-	CR 1/3 N	-	CR 1225	-	CR1225	-
30 years	30 years	10 years	10 years	10 years	10 years	10 years	10 years	10 years	10 years	10 years	10 years	10 years	30 years	30 years	10 years	10 years	10 years	10 years

STEINER-OPTIK

\* Restricted function of electronics at temperatures under -20 °C and above +60 °C \*\* 2 years on electronic parts

# RIFLESCOPES

	HUNTING RIFLESCOPES								SHOOTING-RIFLESCOPES					
	Ranger 6 1-6x24	Ranger 6 3-18x56	Ranger 4 1-4x24	Ranger 4 1-4x24 ZM-Rail	Ranger 4 2.5-10x50	Ranger 4 3-12x56	Ranger 4 3-12x56 ZM-Rail	Ranger 4 6-24x56	M7Xi IFS 4-28x56	M7Xi IFS 2,9-20x50	M7Xi 4-28x56	M7Xi 2,9-20x50	M5Xi 5-25x56	M8Xi 1-8x24
Item No.	8765900204	8767900204* 8767900230**	8769900204	8769903204	8770900204	8771900204	8771903204	8774900404	8719003601	8717003621	8719000101	8716008421	8704000101	8723000226
Effective objective diameter	24,0 - 12,0 mm	56,0 - 35,0 mm	24,0 - 8,0 mm	24,0 - 8,0 mm	50,0 - 18,0 mm	56,0 - 29,0 mm	56,0 - 29,0 mm	56,0 - 48,0 mm	56,0 - 37,8 mm	50,0 - 26,9 mm	56,0 - 37,8 mm	50,0 - 26,95 mm	56,0 - 49 mm	24,0 - 10,3 mm
Magnification min. / max.	1 x / 6 x	3 x / 18 x	1 x / 4 x	1 x / 4 x	2,5 x / 10 x	3 x / 12 x	3 x / 12 x	6 x / 24 x	4 x / 28 x	2,9 x / 20 x	4 x / 28 x	2,9 x / 20 x	5 x / 25 x	1 x / 8 x
Weight	490 g	754 g	500 g	532 g	620 g	640 g	672 g	680 g	1.150 g	1.100 g	950 g	920 g	1.000 g	650 g
Length	268 mm	338 mm	290 mm	290 mm	340 mm	354 mm	354 mm	375 mm	390 mm	352 mm	387 mm	390 mm	422 mm	260 mm
Length of Rail	-	-	-	145 mm	-	-	145 mm	-	-	-	-	-	-	-
Temperature range	-25 °C to +65 °C	-25 °C to +65 °C	-25 °C to +63 °C	-25 °C to +63 °C	-25 °C to +63 °C	-25 °C to +63 °C	-25 °C to +63 °C	-25 °C to +63 °C	-32 °C to +63 °C	-32 °C to +63 °C	-46 °C to +63 °C	-46 °C to +63 °C	-25 °C to +63 °C	-46 °C to +63 °C
Exit pupil	4,35 - 10,45 mm	3,8 - 10,0 mm	7,8 - 5,5 mm	7,8 - 5,5 mm	7,8 - 5,0 mm	9,5 - 4,5 mm	9,5 - 4,5 mm	8,2 - 2,0 mm	12,0 - 6,0 mm	9,18 - 2,5 mm	12,0 - 4,7 mm	9,18 - 2,5 mm	9,8 - 2,2 mm	12,0 - 4,5 mm
Field of view at 100 m	≥ 40,75 - 7,0 m	≥ 14,05 - 2,41 m	≥ 40 - 10 m	≥ 40 - 10 m	≥ 16 - 4,0 m	≥ 13 - 3,3 m	≥ 13 - 3,3 m	≥ 6,7 - 1,7 m	9,0 - 1,4 m	12 - 1,8 m	9,0 - 1,4 m	12,0 - 1,78 m	7,2 - 1,4 m	34,2 - 4,5 m
Eye relief	90 mm	90 mm	90 mm	90 mm	90 mm	90 mm	90 mm	90 mm	87 mm	87 mm	87 mm	87 mm	90 mm	87 mm
Dioptr setting	-3 to +2	-3 to +2	-3 to +2	-3 to +2	-3 to +2	-3 to +2	-3 to +2	-3 to +2	-3 to +2	-3 to +2	-3 to +2	-3 to +2	-3 to +2	-3 to +2
Parallax adjustment	100 m fix	50 m to infinity	100 m fix	100 m fix	100 m fix	100 m fix	100 m fix	50 m to infinity	50 m to infinity	50 m to infinity	50 m to infinity	50 m to infinity	50 m to infinity	100 m fix
Reticle	4A-I	4A-I S3-I	4A-I	4A-I	4A-I	4A-I	4A-I	4A-I	G2B Mil-Dot MSR-2 TReMoR3	G2B Mil-Dot MSR-2 TReMoR3	G2B Mil-Dot MSR-2	G2B Mil-Dot MSR-2 TReMoR3	G2B Mil-Dot, MSR2, B4I-BE2, TReMoR3	DMR8i
Focal plane location	2nd focal plane	2nd focal plane	2nd focal plane	2nd focal plane	2nd focal plane	2nd focal plane	2nd focal plane	2nd focal plane	1st focal plane	1st focal plane	1st focal plane	1st focal plane	1. FP (B4I = 2.FP)	2nd focal plane
Reticle adjustment per click at 100 m	1 cm	1 cm	1 cm	1 cm	1 cm	1 cm	1 cm	1 cm	1 cm	1 cm	1 cm	1 cm	1 cm	1 cm
Max. adjustment in cm at 100m - elevation/windage	300 cm / 300 cm	170 cm / 110 cm	145 cm / 145 cm	145 cm / 145 cm	145 cm / 145 cm	116 cm / 116 cm	116 cm / 116 cm	72 cm / 72 cm	270 cm / 60 cm	270 cm / 60 cm	270 cm / 120 cm	270 cm / 60 cm	260 cm / 120 cm	270 cm / 120 cm
Objective tube diameter	30 mm	63,5 mm	24 mm	24 mm	50 mm	56 mm	56 mm	56 mm	62 mm	57 mm	62 mm	57 mm	62 mm	34 mm
Center tube diameter	30 mm	30 mm	30 mm	30 mm	30 mm	30 mm	30 mm	30 mm	34 mm	34 mm	34 mm	34 mm	34 mm	34 mm
Eye piece diameter	44 mm	44 mm	40 mm	40 mm	40 mm	40 mm	440 mm	40 mm	44,3 mm	44,3 mm	44,3 mm	44,3 mm	44,3 mm	44,3 mm
Reticle illumination	11 steps (6x night, 5x day) and OFF position between each step	11 steps (6x night, 5x day) and OFF position between each step	11 steps (6x night, 5x day) and OFF position between each step	11 steps (6x night, 5x day) and OFF position between each step	11 steps (6x night, 5x day) and OFF position between each step	11 steps (6x night, 5x day) and OFF position between each step	11 steps (6x night, 5x day) and OFF position between each step	11 steps (6x night, 5x day) and OFF position between each step	11 steps (6x night, 5x day) and OFF position between each step	11 steps (6x night, 5x day) and OFF position between each step	11 steps (6x night, 5x day) and OFF position between each step	11 steps (6x night, 5x day) and OFF position between each step	11 steps (7x day, 4x night) and OFF position between each step	11 steps (6x night, 5x day) and OFF position between each step
High-Performance-Optics	High Contrast- ED	High Contrast- ED	High Contrast	High Contrast	High Contrast	High Contrast	High Contrast	High Contrast	High Contrast	High Contrast	High Contrast	High Contrast	High Contrast	High Contrast
Steiner Nano-Protection	-	-	-	-	-	-	-	-	yes	yes	yes	yes	yes	yes
Water-Pressure Proof	up to 2 m	up to 2 m	up to 1 m	up to 1 m	up to 1 m	up to 21 m	up to 1 m	up to 1 m	up to 20 m	up to 20 m	up to 20 m	up to 20 m	up to 10 m	up to 10 m
Steiner Nitrogen-Pressure-System	yes	yes	yes	yes	yes	yes	yes	yes	yes	yes	yes	yes	yes	yes
Accessories	Objective- and ocular lens cover	Objective- and ocular lens cover	Objective- and ocular lens cover	Objective- and ocular lens cover	Objective- and ocular lens cover	Objective- and ocular lens cover	Objective- and ocular lens cover	Objective- and ocular lens cover	Objective- and ocular lens cover	Objective- and ocular lens cover	Objective- and ocular lens cover	Objective- and ocular lens cover	Objective- and ocular lens cover	Objective- and ocular lens cover
Warranty	10 years ***	10 years ***	10 years ***	10 years ***	10 years ***	10 years ***	10 years ***	10 years ***	10 years ***	10 years ***	10 years ***	10 years ***	10 years ***	10 years ***



STEINER-OPTIK

# SPECIFICATIONS

	RED DOT SIGHT		SIGHTS					
	MRS Micro Reflex Sight	MRS Micro Reflex Sight	MPS Micro Pistol Sight	S332 Sight	S432 Sight	T332 Sight	T432 Sight	T536 Sight
Item No.	8700000000	8700000003	8700000025	8793900103	8794900103	8796900103	8797900103	8798900103
Item No. with rail	-	-	-	-	-	-	-	-
Rail	Picatinny	Universal	Docter System	-	-	-	-	-
Effective objective diameter	21 x 15 mm	21 x 15 mm	20 x 16 mm	32 mm	32 mm	32 mm	32 mm	36 mm
Magnification min. / max.	1 x	1 x	1 x	3 x	4 x	3 x	4 x	5 x
Weight with mount	<70 g	<70 g	94 g	-	-	-	-	-
Weight without mount		88 g	58 g	620 g	734 g	450 g	470 g	500 g
Length	46 mm	46 mm	45 mm	139 mm	142 mm	122 mm	129 mm	144 mm
Temperature range	-25 °C to +55 °C	-25 °C to +55 °C	-40 °C to +60 °C	-30 °C to +65 °C	-30 °C to +65 °C	-20 °C to +60 °C	-20 °C to +60 °C	-20 °C to +60 °C
Exit pupil	-	-	-	9,5 mm	7 mm	10,2 mm	7,6 mm	7,2 mm
Field of view at 100 m	-	-	-	14,1 m	11,8 m	10,5 m	7,9 m	6,3 m
Eye relief	-	-	-	≥ 77 mm	≥ 77 mm	≥ 70 mm	≥ 70 mm	≥ 70 mm
Diopter setting	-	-	-	-3 to +3	-3 to +3	-2 to +2	-2 to +2	-2 to +2
Parallax adjustment	40 m fix	40 m fix	25 m fix	100 m	100 m	100 m	100 m	100 m
Reticle	3 MOA Dot	3 MOA Dot	3,3 MOA Dot	Rapid-Dot	Rapid-Dot	Rapid-Dot	Rapid-Dot	Rapid-Dot
Focal plane location	-	-	-	-	-	-	-	-
Reticle adjustment per click at 100 m	1 MOA @ 100 m 30 Clics per Rotation	1 MOA @ 100 m 30 Clics per Rotation	1 MOA @ 100 m 28 Clics per Rotation	1 cm	1 cm	1 cm	1 cm	1 cm
Max. adjustment in cm at 100m - elevation/windage	90 MOA / 90 MOA	90 MOA / 90 MOA	90 MOA / 90 MOA	50 MOA / 50 MOA	50 MOA / 50 MOA	50 MOA / 50 MOA	40 MOA / 40 MOA	35 MOA / 40 MOA
Objective tube diameter	-	-	-	-	-	-	-	-
Center tube diameter	-	-	-	-	-	-	-	-
Eye piece diameter	21 x 15 mm	21 x 15 mm	20 x 16 mm					
Reticle illumination	4 steps: automatic, low, medium, high, 2x NV	4 steps: automatic, low, medium, high, 2x NV	8 steps: (6x day/night 2x nightvision) Auto off a. 13h	8 steps: (5x day, 2x night 1x nightvision)	8 steps: (5x day, 2x night 1x nightvision)	8 steps: (5x day, 3x night 2x nightvision)	8 steps: (5x day, 3x night 2x nightvision)	8 steps: (5x day, 3x night 2x nightvision)
High-Performance-Optics	High Contrast	High Contrast	High Contrast	High Contrast	High Contrast	High Contrast	High Contrast	High Contrast
Steiner Nano-Protection	-	-	-	-	-	-	-	-
Water-Pressure Proof	up to 2 m	up to 2 m	up to 10 m	up to 10 m	up to 10 m	up to 5 m	up to 5 m	up to 5 m
Steiner Nitrogen-Pressure-System	yes	yes	yes	yes	yes	yes	yes	yes
Accessories	-	-	-					
Warranty	10 years ***	10 years ***	10 years ***	10 years ***	10 years ***	10 years ***	10 years ***	10 years ***

## RETICLE SUBSTENSIONS 4A-I, S3-I AND G2B MIL-DOT

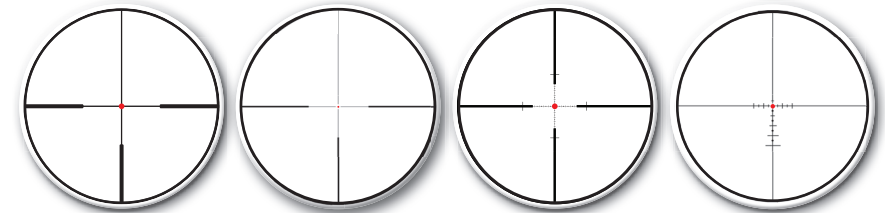

Reticle 4A-I illuminated Ranger 6

Reticle 4A-I illuminated Ranger 4

G2B Mil-Dot

Reticle S3-I illuminated

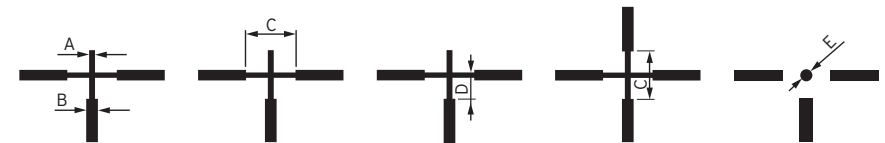

Substensions in cm at 100 m at min. / max. magnification.

	1-4x24		2.5-10x50		3-12x56		6-24x56	
	1x	4x	2.5x	10x	3x	12x	6x	24x
A	7.5	1.9	3.0	0.75	2.5	0.6	1.27	0.32
B	36.0	9.0	14.4	3.6	12.0	3.0	6	1.5
W	1,440	360	576	144	480	120	240	60
D	16.3	4.1	6.5	1.6	5.4	1.4	2.73	0.68

	1-6x24		3-18x56	
	1x	6x	3x	18x
A	7.5	1.3	2.5	0.42
B	36.0	6.0	12.0	2.00
W	1,440	240	480	80
D	6.6	1.1	2.2	0.4

## RETICLES S-SIGHTS T-SIGHTS

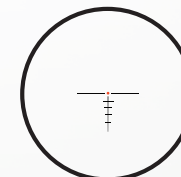

RAPID DOT

## RETICLE M8XI



DMR81

## RETICLE M5Xi/M7Xi/M7Xi IFSi

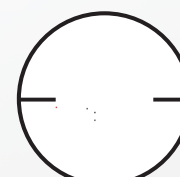

MSR2



G2B MIL-DOT

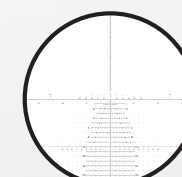

TREMOR3



B4I-BE2

STEINER-OPTIK

# ACCESSORIES

All STEINER products come with extensive accessories. Please see the details on each product page or the technical data pages 58 - 61.

## RANGER



### FLIP COVER FOR RIFLESCOPES

Lens and eyepiece protection for Ranger rifle scopes. Practical folding mechanism with no-noise system.

**Item-No. 77020000**  
(for Ranger 4 1-4x24)

**Item-No. 77040000**  
(for Ranger 4 3-12x56,  
Ranger 4 4-16x56 and  
Ranger 4 6-24x56)

**Item-No. 76910000**  
(for Ranger 6 1-4x24)

**Item-No. 76930000**  
(for Ranger 6 3-18x56)



**Item-No. 77010000**  
(for Ranger 4 models)



**Item-No. 76980000**  
(for Ranger 6 models)

### RANGER BALLISTIC CAPS

The new Ranger BC riflescopes are equipped with five different cap sets, covering all important hunting bullets and calibers. Depending on the used caliber the corresponding cap is attached, then you just need a precise and quick reticle adjustment for a perfect shot.



## COMFORT-HARNESS



Comfort Harness permits hands-free and comfortable binocular carry.

Raise the binocular to your eyes for quick viewing, return it to your chest when done. Binocular is securely attached to the adjustable harness, removable quick-release buckles. Relieves neck and back muscles and is secure and easy to use.

**Item-No. 76900000**  
(fits all models, except compacts)



### FLOATING STRAP

Floating Strap padded in a visible yellow, water-repellent, long-lasting waterproof jacket with integrated 3M fluorescent strip that keeps the binocular floating and reflects also in darkness. For maximum security on board.

**Art.-Nr. 76800003**  
(for Commander models)

**Art.-Nr. 76990000**  
(for Navigator 7x30  
and Navigator 7x50 models)



STEINER-OPTIK

## STEINER WARRANTY. PERFORMANCE YOU CAN PASS DOWN.

With every STEINER optical product comes a lifelong relationship, with you and yours. We build trusted optics for life's defining moments. Pursuit of these moments demands quick detection, location and identification of your objective through your most important sense, vision. Be it in pursuit of wild life, a marine bearing, law enforcement suspect or military combatant, our commitment to quality and the STEINER Warranty is our promise that Nothing Escapes You.



The world wide 10 to 30 year STEINER Warranty means we stand behind our products. Over half a century of experience building rugged and reliable, mil-spec product and supplying them to professionals, amateurs and also armed forces all around the world allows us to have this

kind of confidence. We at STEINER are totally committed to the very highest standards of quality, dependability, and most of all customer satisfaction. Our Warranty assures you of that commitment. However, should one become defective within the warranty period, for any

reason other than theft or deliberate misuse, we will service it at no charge - no questions asked. We kindly ask for your understanding that wear parts such as rubber armouring, carrying straps, eyecups or lens covers are not included in the scope of warranty.

If you have already purchased a STEINER product, kindly fill out the warranty registration: [www.steiner.de](http://www.steiner.de)

## CUSTOMER SERVICE

Need repair or spare parts?  
Have questions or comments, need information or advice?  
Whenever you need help: please contact our expert team.

INTERNATIONAL  
E-Mail: [service@steiner.de](mailto:service@steiner.de)  
Tel: +49 (0) 921 7879-815



@SteinerHunting  
@SteinerMarine  
@SteinerAdventure



@steiner\_hunting  
@steiner\_marine  
@steiner\_adventure



STEINEROPTIK



[WWW.STEINER.DE](http://WWW.STEINER.DE)

**STEINER**   
Nothing Escapes You

# STEINER



Nothing Escapes You

.....

[WWW.STEINER.DE](http://WWW.STEINER.DE)

**STEINER-OPTIK GMBH**

Dr.-Hans-Frisch-Str. 9 · 95448 Bayreuth · Germany

Tel. +49 921 7879-851 · Fax +49 921 7879-89

[service@steiner.de](mailto:service@steiner.de)

.....



STEINER-OPTIK is a  
Beretta Holding company



HUNTING



SHOOTING



ADVENTURE

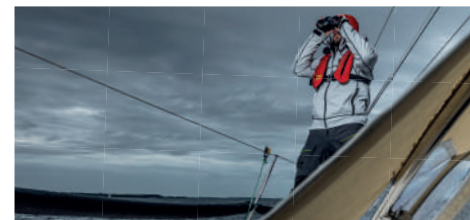

MARINE